

제 26 호

고급현관문 · 단열도어 · 대문 · 모라논 · 폴딩도어

현관문
폴딩도어
시스템도어
슬림중문
중문
대문
웬스
벤치



Plus Door



Plus+ Door (주) 청주금속 플러스도어

본사 · 공장: 충북 청주시 서원구 가좌신송로 15

TEL:(043)221-2600~1 / FAX:(043)221-2603 www.plusdoor.com

▶ 본 제품을 무단 복제 하거나 도용하여 사용하는 것은 해당법에 의해 처벌받습니다

Plus+ Door
(주) 청주금속 플러스도어
www.teuin.net 특인.

 특허출원 디자인등록
 시험성적서 보유
열관류율 1.11 기밀 1등급

Plus+ Door (주) 청주금속 플러스도어

Door Contents

로이도어 Roy Door	04
나인도어 Nine Door	24
트윈도어 Twin Door	48
일반도어 General Door	60
폴딩도어 Folding Door	82
시스템도어 System Door	90
중 문 Inner Door	91
대 문 Gate	108
판 널 Panel	136
휨 스 Fence	146
벤 치 Bench	157
기 타 Other	159



Color Index

- SM 소프트메이플
- LW 라이트월넛
- BG 버치그레이
- GL 그레이라인
- GH 골드헤어라인
- DS 다크서스
- DO 다크오크
- MB 모카브라운
- BT 베이직티크

SM

LW

BG

GL

GH

DS

DO

MB

BT



유럽형 고기밀, 고단열 현관도어 - 로이도어 -

특징

1. 높아진 기밀성-바람막이 날개가 4면으로 되어 있어 기밀성을 극대화 하였습니다.
2. 강화된 단열성능- 고성능 단열설계로 열관류율 1.11을 획득하였습니다.
3. 낮은 열전도율- 알미늄 프로파일에 합성수지재를 접합하여 열전도율을 대폭 낮췄습니다.
4. 유리 마감부위를 실리콘처리를 하지않고 EPDM 가스켓을 사용하였습니다.
5. Fix 부분이 교체 가능하여 찍힘이나 파손시 후레임 전체를 교체하지 않아도 됩니다.
6. 3중유리로 단열성능을 높였으며 채광이 가능합니다.



<열관류율 1.11 기밀 1등급>

신제품 단면

폴리아미드 가스켓을 일정한 부위에 삽입하여 열전도 차단구간을 만들었습니다.
금속이 연결되어 있지 않아 외부의 온도가 내부로 전달되지 않습니다.

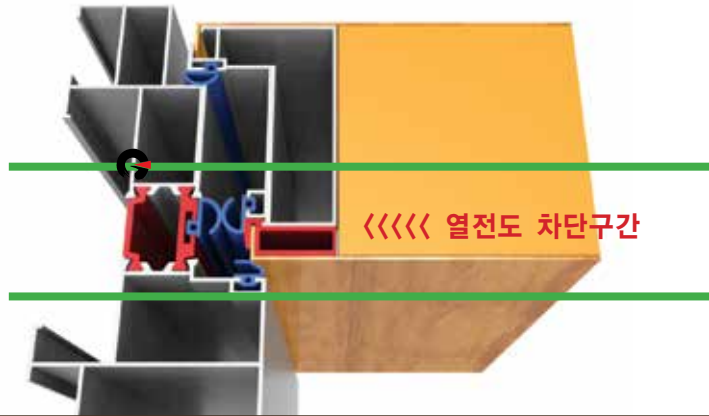

<<<< 열전도 차단구간 >>>>

특허출원

특허출원번호: 10-2018-0079541

【발명의 명칭】

개선된 단열 및 방풍 구조를 갖는 현관문(FRONT DOOR HAVING IMPROVED STRUCTURE FOR PROTECTION AGAINST WIND AND INSULATION)

【기술분야】

본 발명은 현관문에 관한 것으로서, 더욱 상세하게는 현관도어부의 외면에 배치되는 철판 등의 금속판재가 갖는 금속 표면에 의한 열전도를 차단함에 의해 단열 성능을 높일 수 있도록 하면서 상하좌우 4면에 대한 방풍구조를 제공함에 의해 기밀성을 높일 수 있도록 한 개선된 단열 및 방풍 구조를 갖는 현관문에 관한 것이다.



바람막이 날개가 돌출되어있지 않아 외관이 미려합니다.

탄성, 복원력이 우수한 EPDM 재질의가스켓을 4중으로 삽입하여 밀폐력을 높였습니다.
또한 문을 닫을 시에 가스켓의 탄성으로인하여 부드럽게 닫힙니다.

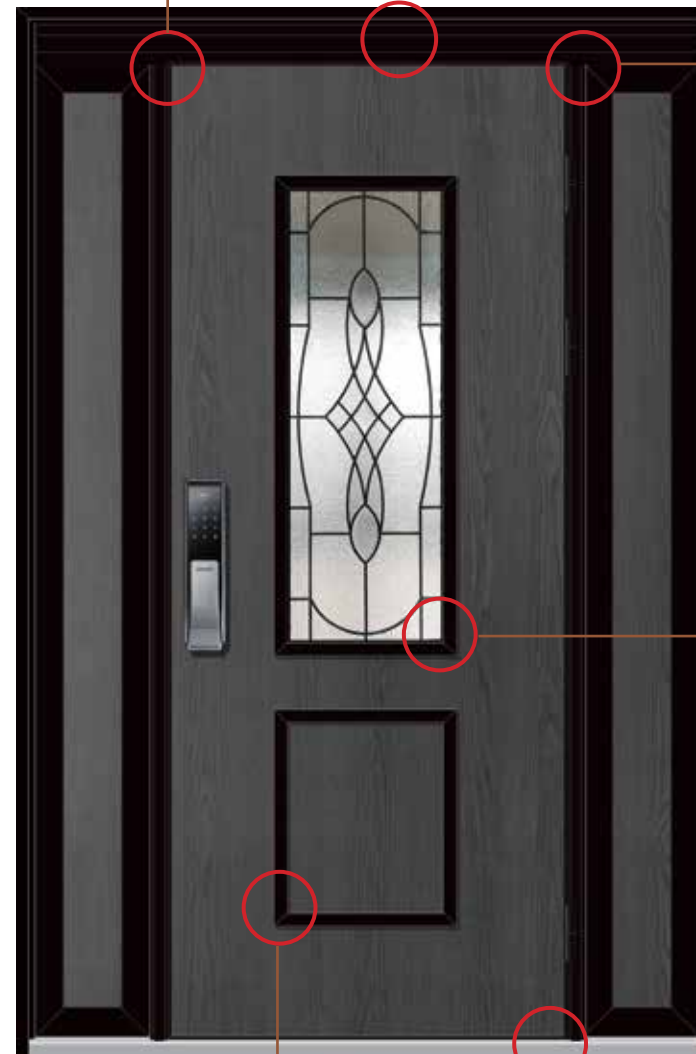

• 4면 날개

바람막이 날개를 상하좌우 4면으로 설계하여 외풍을 차단하는데 효과적입니다.

• 3중 유리구조

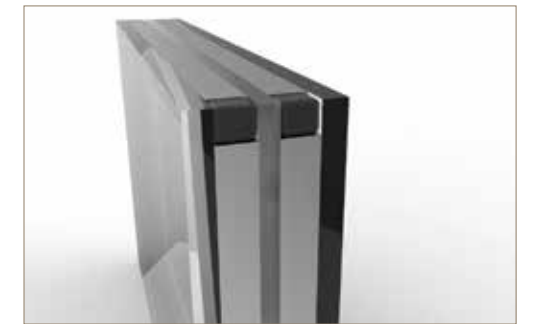

<3중유리> 5mm+12스페이서+3mm폴리+6스페이서+5mm 유리부분을 3중으로 하여 기존의 페어유리보다 단열성능이 우수합니다.



모서리 부분에 플라스틱 마감재를 사용하여 날카로운 부분을 없앴습니다.



하부셀에 돌기를 주어 미끄러짐을 방지 하였습니다.



미끄러방지돌기

디자인등록 출원번호 제 30-2018-0025083호

특허출원
성적서 보유제품



1101 DO(다크오크)



Fix를 유리로 변경 가능합니다.

1101 Front Door Color Chart | 1101 현관문



1101 BG(버치그레이)



1101 BT(베이지티크)



1101 LW(라이트월넛)



1101 MB(모카브라운)



1101 SM(소프트메이플)

Roy Door Type | 로이도어 사이즈별 타입

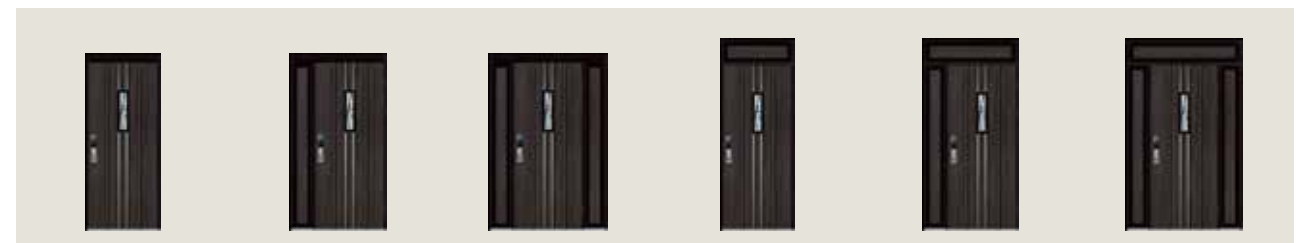

문짝형	외소대형	양소대형	문짝남마형	외소대남마형	양소대남마형
W800~1150	W1150~1400	W1400~이상	W800~1150	W1150~1400	W1400~이상
H~2500까지	H~2500까지	H~2500까지	H2500~이상	H2500~이상	H2500~이상

* 문짝형 W1050~1150은 후레임에 알미늄바가 추가 부착됩니다.

특허출원 성적서 보유제품

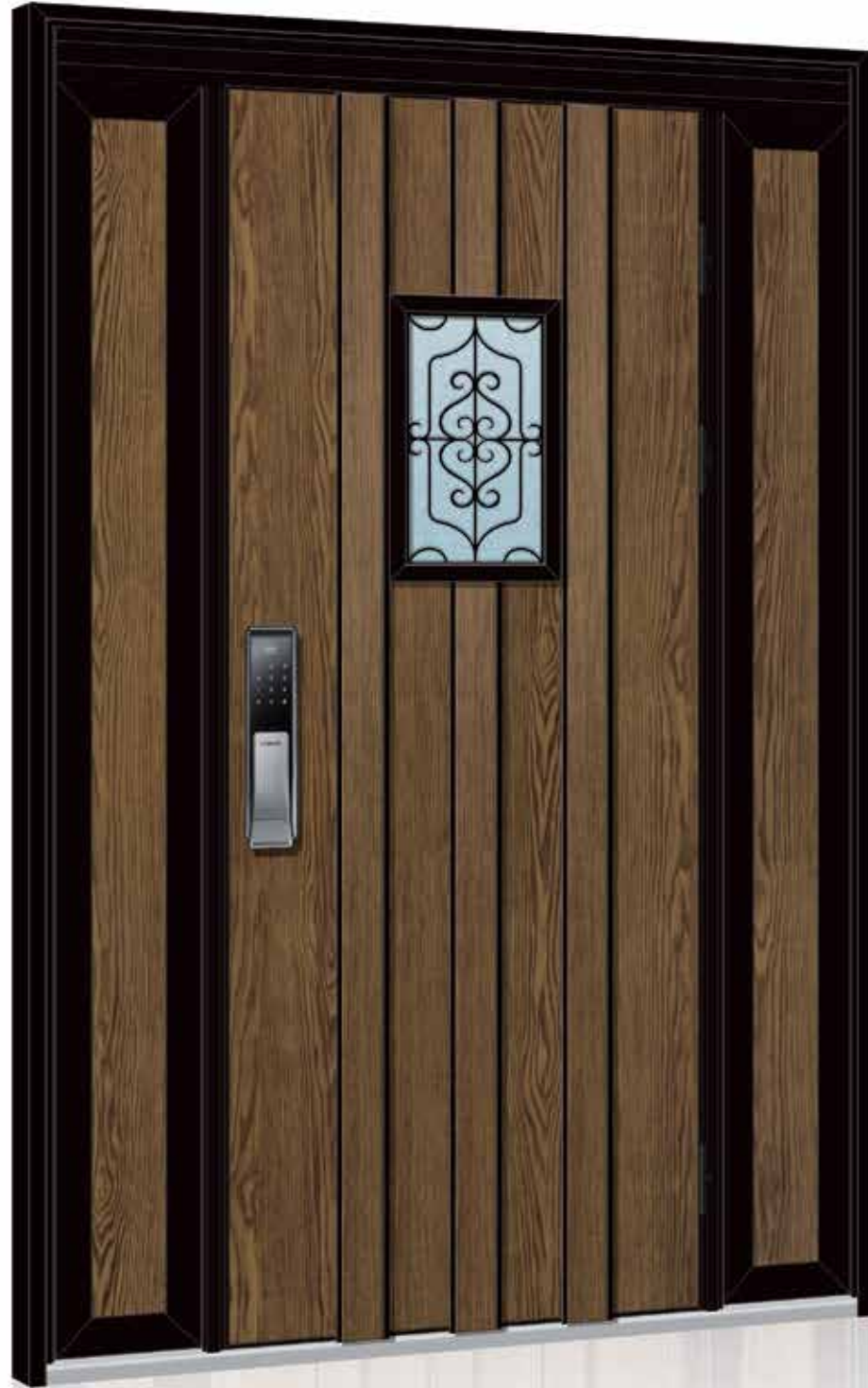

1102 MB(모카브라운)



Fix를 유리로 변경 가능합니다.

1102 Front Door Color Chart | 1102 현관문



1102 BG(버치그레이)



1102 BT(베이직티크)



1102 DO(다크오크)



1102 LW(라이트월넛)



1102 SM(소프트메이플)

Roy Door Type | 로이도어 사이즈별 타입



문짝형	외소대형	양소대형	문짝남마형	외소대남마형	양소대남마형
W800~1150	W1150~1400	W1400~이상	W800~1150	W1150~1400	W1400~이상
H~2500까지	H~2500까지	H~2500까지	H2500~이상	H2500~이상	H2500~이상

* 문짝형 W1050~1150은 후레임에 알미늄바가 추가 부착됩니다.

특허출원 성적서 보유제품



1103 BT(베이틱티크)



Fix를 판으로 변경 가능합니다.

1103 Front Door Color Chart | 1103 현관문



1103 BG(버치그레이)

1103 DO(다크오크)

1103 DS(다크서스)

1103 LW(라이트월넛)



1103 MB(모카브라운)

1103 SM(소프트메이플)

Roy Door Type | 로이도어 사이즈별 타입



문짝형	외소대형	양소대형	문짝남마형	외소대남마형	양소대남마형
W800~1150	W1150~1400	W1400~이상	W800~1150	W1150~1400	W1400~이상
H~2500까지	H~2500까지	H~2500까지	H2500~이상	H2500~이상	H2500~이상

* 문짝형 W1050~1150은 후레임에 알미늄바가 추가 부착됩니다.

디자인등록 출원번호 제 30-2018-0025084호

특허출원
성적서 보유제품

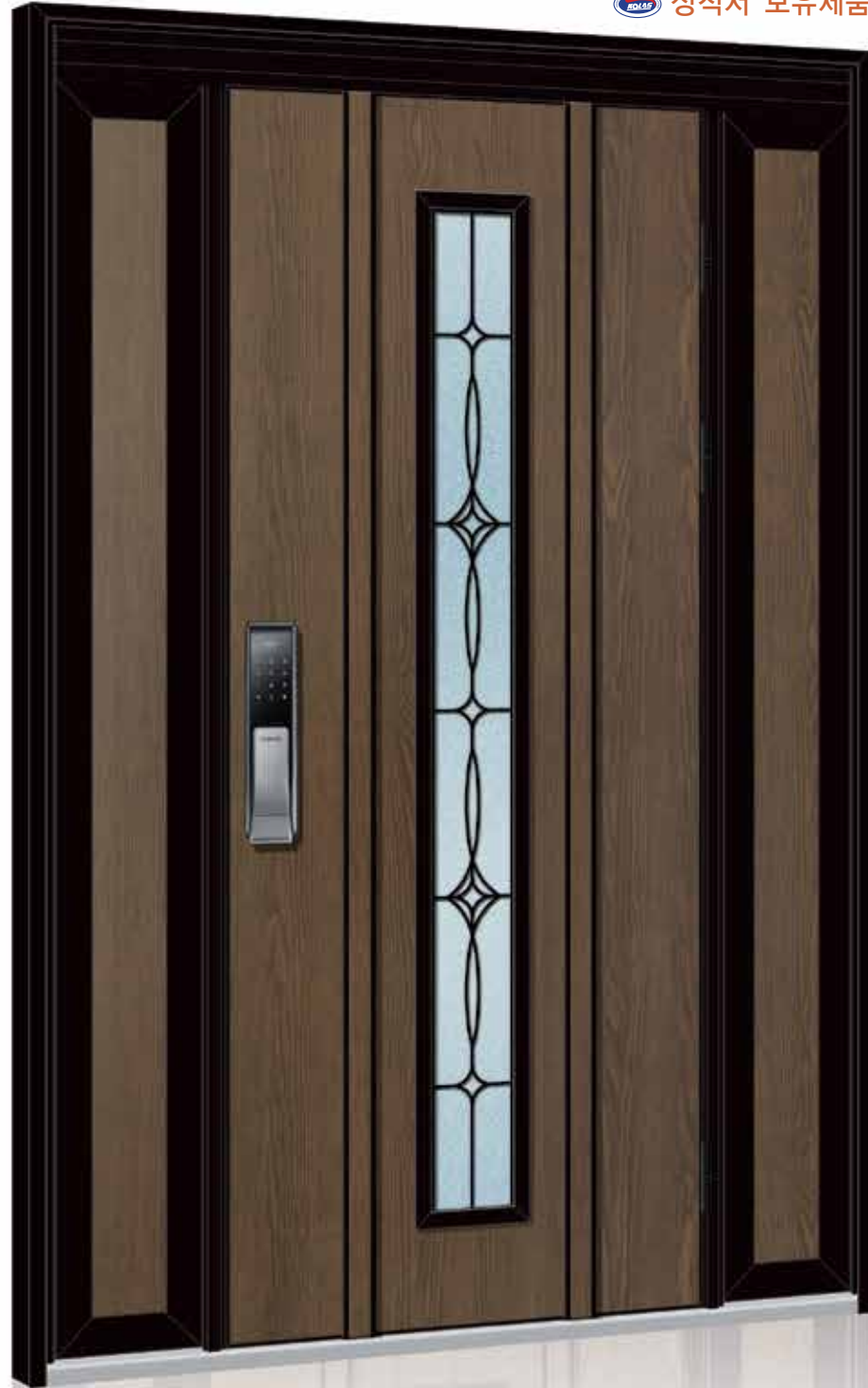

1104 LW(라이트월넛)



Fix를 유리로 변경 가능합니다.

1104 Front Door Color Chart | 1104 현관문



1104
BG(버치그레이)

1104
BT(베이지티크)

1104
DO(다크오크)

1104
DS(다크서스)



1104
GL(그레이라인)

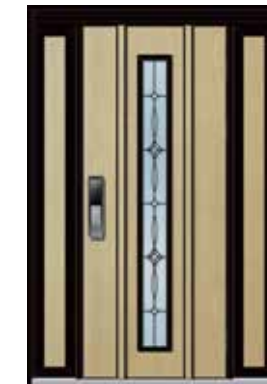

1104
SM(소프트메이플)



1104
MB(모카브라운)

Roy Door Type | 로이도어 사이즈별 타입



문짝형	외소대형	양소대형	문짝남마형	외소대남마형	양소대남마형
W800~1150	W1150~1400	W1400~이상	W800~1150	W1150~1400	W1400~이상
H~2500까지	H~2500까지	H~2500까지	H2500~이상	H2500~이상	H2500~이상

* 문짝형 W1050~1150은 후레임에 알미늄바가 추가 부착됩니다.

특허출원 성적서 보유제품



1105 DO+MB(다크오크+모카브라운)



Fix를 판으로 변경 가능합니다.

1105 Front Door Color Chart | 1105 현관문



1105 DO+BG (다크오크+버치그레이)



1105 DO+LW (다크오크+라이트월넛)



1105 DS+DO (다크스테인+다크오크)



1105 MB+BT (모카브라운+베이지티크)

Roy Door Type | 로이도어 사이즈별 타입



문짝형	외소대형	양소대형	문짝남마형	외소대남마형	양소대남마형
W800~1150	W1150~1400	W1400~이상	W800~1150	W1150~1400	W1400~이상
H~2500까지	H~2500까지	H~2500까지	H2500~이상	H2500~이상	H2500~이상

* 문짝형 W1050~1150은 후레임에 알미늄바가 추가 부착됩니다.

특허출원 성적서 보유제품



1106 BG(버치그레이)



Fix를 판으로 변경 가능합니다.

1106 Front Door Color Chart | 1106 현관문



1106 BT(베이지티크)



1106 DO(다크오크)



1106 LW(라이트월넛)



1106 MB(모카브라운)

Roy Door Type | 로이도어 사이즈별 타입



문짝형	외소대형	양소대형	문짝남마형	외소대남마형	양소대남마형
W800~1150	W1150~1400	W1400~이상	W800~1150	W1150~1400	W1400~이상
H~2500까지	H~2500까지	H~2500까지	H2500~이상	H2500~이상	H2500~이상

* 문짝형 W1050~1150은 후레임에 알미늄바가 추가 부착됩니다.

디자인등록 출원번호 제 30-2018-0025085호

특허출원
성적서 보유제품

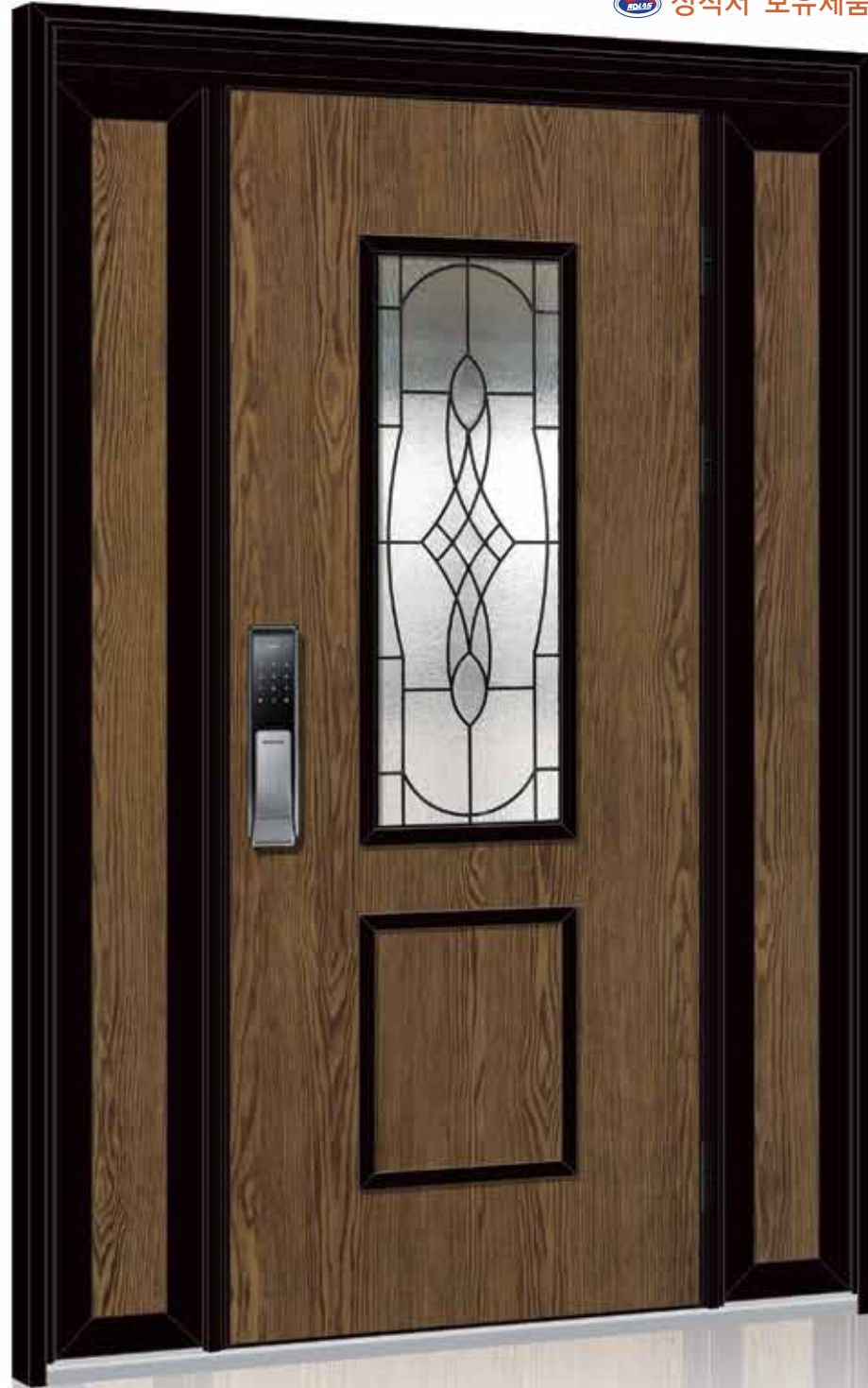

1107 MB(모카브라운)



Fix를 유리로 변경 가능합니다.

1107 Front Door Color Chart | 1107 현관문



1107 BG(버치그레이)



1107 BT(베이직티크)



1107 DO(다크오크)



1107 LW(라이트월넛)



1107 SM(소프트메이플)

Roy Door Type | 로이도어 사이즈별 타입



문짝형	외소대형	양소대형	문짝남마형	외소대남마형	양소대남마형
W800~1150	W1150~1400	W1400~이상	W800~1150	W1150~1400	W1400~이상
H~2500까지	H~2500까지	H~2500까지	H2500~이상	H2500~이상	H2500~이상

* 문짝형 W1050~1150은 후레임에 알미늄바가 추가 부착됩니다.

원목사용

특허출원 성적서 보유제품



1108 연결(적삼목사용)
*목재특성상 색상배열이 다를 수 있습니다.



Fix를 나무로 변경 가능합니다.

1108 Front Door Color Chart | 1108 현관문



1108 투명



1108 도토리

Roy Door Type | 로이도어 사이즈별 타입

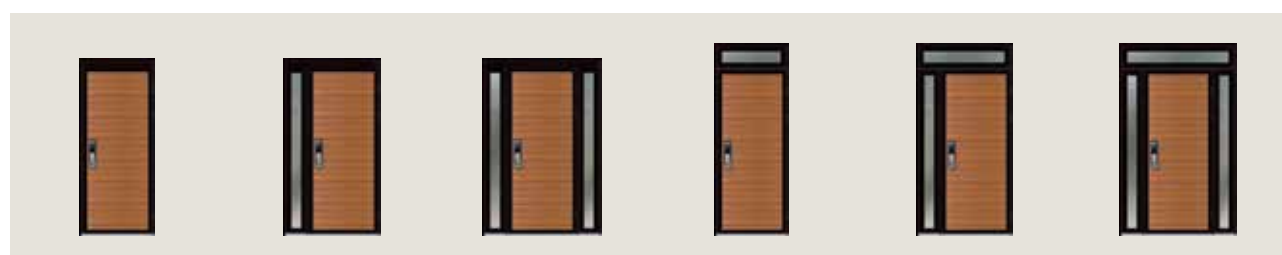

문짝형	외소대형	양소대형	문짝남마형	외소대남마형	양소대남마형
W800~1150	W1150~1400	W1400~이상	W800~1150	W1150~1400	W1400~이상
H~2500까지	H~2500까지	H~2500까지	H2500~이상	H2500~이상	H2500~이상

* 문짝형 W1050~1150은 후레임에 알미늄바가 추가 부착됩니다.

Nine Door | 나인도어

알루미늄 프로파일과 복합판넬을 사용하여 조립한 도어로 단열성능 및 방음성능을 향상 시켰습니다.

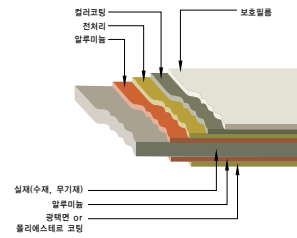

복합판넬사용



매립형도어체크



매립형한지



전자키 기본(볼트)

나인도어 단열형 • 후레임 140mm / 문짝 55mm

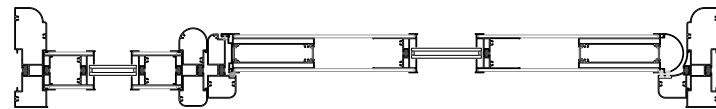

< 알루미늄 중간에 단열층을 삽입하여 외부의 열전도를 차단합니다. >

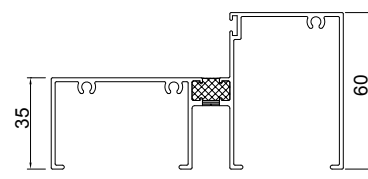

< 문지방도면 >

나인도어 • 후레임 130mm / 문짝 47mm

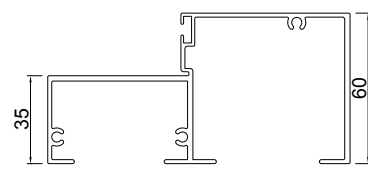
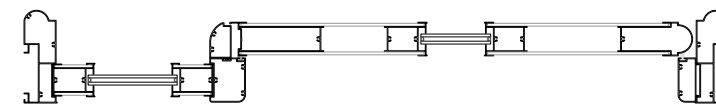

< 문지방도면 >

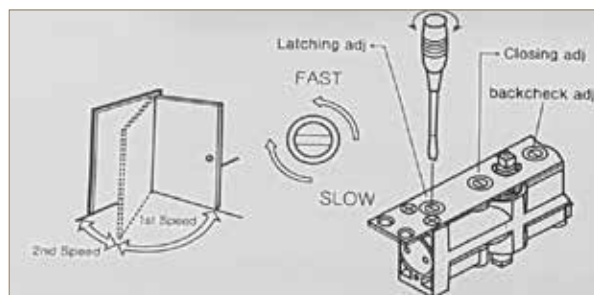

1번과 2번을 +방향으로 돌리면 속도가 빨라지고 -쪽으로 돌리면 속도가 느려집니다.

도어클로저는 문짝 상부에 있습니다.



프레임 상부의 고정장치의 위치를 이동하여 현관문의 열림각도를 조절 할 수 있습니다.

스톱퍼의 볼트 2개를 십자드라이버로 풀어 다른 구멍으로 이동시킵니다.



Key Collection | 키 모음집

삼성푸쉬록 D710	게이트맨 WS200	게이트아이	볼트	봉키실버



1281

(아존단열 140mm후레임)

내장도어체크,
매립형힌지 사용
알미늄 색상:블랙
전면 다크서스+적삼목 무절
후면 다크그레이

*목재특성상 카다로그와
색상차이가 있을 수 있습니다.



1280

(아존단열 140mm후레임)

내장도어체크,
매립형힌지 사용
알미늄 색상:실버
전면 다크서스+적삼목 무절
후면 다크그레이

*목재특성상 카다로그와
색상차이가 있을 수 있습니다.



스와로브스키란?

오스트리아의 크리스탈 기공업체 브랜드로 보석류, 악세사리, 장식용 제품에 쓰이는 고급 크리스탈임.

디자인등록 출원번호 제 30-2018-0025089호



1293 (아존단열 140mm후레임)

293 (130mm 알미늄 후레임)

내장도어체크, 매립형힌지 사용
알미늄 색상:블랙 / 전면 블랙, 다크서스
후면 다크그레이 / 스와로브스키



1294 (아존단열 140mm후레임)

294 (130mm 알미늄 후레임)

내장도어체크, 매립형힌지 사용
알미늄 색상:블랙 / 전면 블랙, 다크서스
후면 다크그레이 / 스와로브스키

High-quality product to meet all.

Products matching humans and nature!

Products providing d high level of design matched wel with people.

디자인등록 출원번호 제 30-2018-0025087호

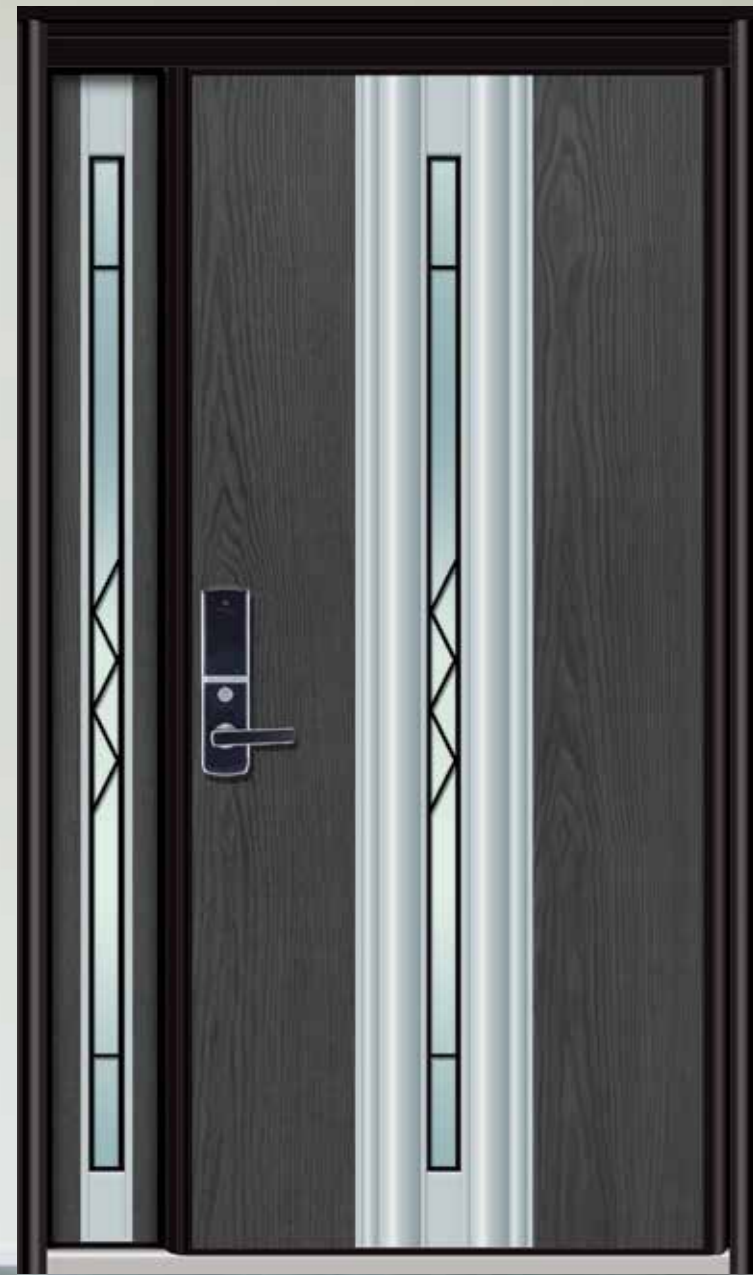

1282 (아존단열 140mm후레임)

282 (130mm 알미늄 후레임)

내장도어체크, 매립형힌지 사용 / 알미늄 색상:블랙+실버
전면 버치그레이 / 후면 다크그레이



디자인등록 출원번호 제 30-2018-0025087호



1283 (아존단열 140mm후레임)

283 (130mm 알미늄 후레임)

내장도어체크, 매립형힌지 사용 / 알미늄 색상:블랙+실버
전면 다크오크 / 후면 샴페인

디자인등록 출원번호 제 30-2018-0025086호



1279 (아존단열 140mm후레임)

279 (130mm 알미늄 후레임)

내장도어체크, 매립형힌지 사용 / 알미늄 색상:블랙
전면 블랙+다크오크 / 후면 블랙, 아쿠아유리

We turn to 'a High quality front door provider

by creating value to grant a new concept for the front door,
by respecting customers specially to offer qualified products and services,
by providing the advanced life styles and high quality products.



1276 (아존단열 140mm후레임)

276 (130mm 알미늄 후레임)

내장도어체크, 매립형힌지 사용
알미늄 색상:블랙+실버
전면 버치그레이 / 후면 다크그레이, 망입유리



1277 (아존단열 140mm후레임)

277 (130mm 알미늄 후레임)

내장도어체크, 매립형힌지 사용
알미늄 색상:블랙+실버
복합판넬 블랙 / 후면 블랙, 망입유리



1289 (아존단열 140mm후레임)

289 (130mm 알미늄 후레임)

내장도어체크, 매립형힌지 사용 / 알미늄 색상:블랙+실버
전면 다크오크 / 후면 다크그레이



1286 (아존단열 140mm후레임)

286 (130mm 알미늄 후레임)

내장도어체크, 매립형힌지 사용 / 알미늄 색상:블랙
전면 다크오크, 골드헤어라인 / 후면 샴페인



1290 (아존단열 140mm후레임)

290 (130mm 알미늄 후레임)

내장도어체크, 매립형힌지 사용 / 알미늄 색상:실버
전면 다크서스 / 후면 실버

High-quality product to meet all.

Products matching humans and nature!

Products providing a high level of design matched well with people.

Nature Beautiful...

세로 슬릿유리와 나무무늬,
그리고 단조를 사용한 제품으로 어느 주택이나
어울리는 고급도어입니다.

디자인등록 제 30-0833987호



1274 (아존단열 140mm후레임)

274 (130mm 알미늄 후레임)
내장도어체크, 매립형힌지 사용
알미늄 색상:블랙
전면 라이트월넛 / 후면 샴페인

디자인등록 제 30-0833987호



1275-1 (아존단열 140mm후레임)

275-1 (130mm 알미늄 후레임)
내장도어체크, 매립형힌지 사용
알미늄 색상:블랙
전면 버치그레이 / 후면 다크그레이

디자인등록 제 30-0833984호



1259 (아존단열 140mm후레임)

259 (130mm 알미늄 후레임)
내장도어체크, 매립형힌지 사용 / 알미늄 색상:블랙
전면 라이트월넛 / 후면 샴페인



1266 (아존단열 140mm후레임)

266 (130mm 알미늄 후레임)
내장도어체크, 매립형힌지 사용
알미늄 색상:블랙, 실버
전면 버치그레이 / 후면 다크그레이

We turn to 'a High quality front door provider
by creating value to grant a new concept for the front door,
by respecting customers specially to offer qualified products and services,
by providing the advanced life styles and high quality products.



1230
(아존단열 140mm후레임)

230
(130mm 알미늄 후레임)

내장도어체크,
매립형힌지 사용
알미늄 색상:블랙
전면 골드헤어라인
후면 샴페인

*현관문의 사이즈에
따라 꽃무늬의 위치가
바뀔 수 있습니다.



1232
(아존단열 140mm후레임)

232
(130mm 알미늄 후레임)

내장도어체크,
매립형힌지 사용
알미늄 색상:블랙
전면 골드헤어라인
후면 샴페인

Modern Style

From refinement to naturalness.

We bring out the eminence without decorating.

The grace beyond eyeshot and the modern atmosphere will take the place of your level.



1291 (아존단열 140mm후레임)

291 (130mm 알미늄 후레임)

내장도어체크, 매립형힌지 사용 / 알미늄 색상:실버
전면 다크서스+다크오크 / 후면 다크그레이



1292 (아존단열 140mm후레임)

292 (130mm 알미늄 후레임)

내장도어체크, 매립형힌지 사용 / 알미늄 색상:블랙
전면 다크서스+다크오크 / 후면 다크그레이

디자인등록 제 30-0833985호



1256-1 (아존단열 140mm후레임)

256-1 (130mm 알미늄 후레임)

내장도어체크, 매립형힌지 사용 / 알미늄 색상:블랙
전면 베이직티크 / 후면 샴페인

디자인등록 제 30-0833985호



1256-2 (아존단열 140mm후레임)

256-2 (130mm 알미늄 후레임)

내장도어체크, 매립형힌지 사용 / 알미늄 색상:블랙
전면 모카브라운 / 후면 샴페인

Antique Style

단조무늬를 사용한 엔틱 스타일 도어로 고풍스럽고 세련된 스타일의 도어입니다.



1241 (아존단열 140mm후레임)

241 (130mm 알미늄 후레임)

내장도어체크, 매립형힌지 사용 / 알미늄 색상:블랙
전면 골드헤어라인 / 후면 샴페인

디자인등록 제 30-0680833호

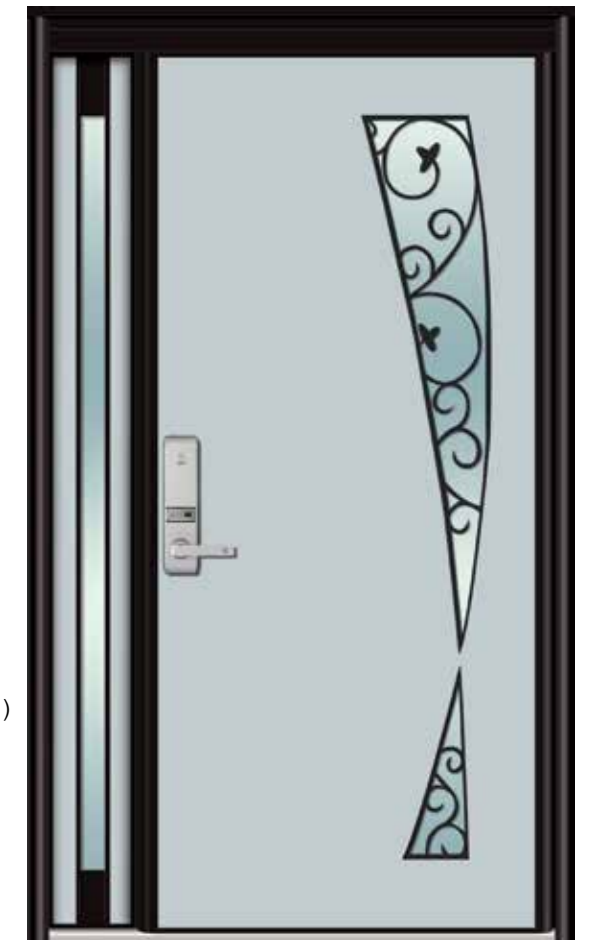

1248-2 (아존단열 140mm후레임)

248-2 (130mm 알미늄 후레임)

내장도어체크, 매립형힌지 사용
알미늄 색상:블랙
복합판넬 실버 / 후면 실버

디자인등록 제 30-0695408호



1243-1 (아존단열 140mm후레임)

243-1 (130mm 알미늄 후레임)

내장도어체크, 매립형힌지 사용 / 알미늄 색상:블랙
전면 블랙 / 후면 블랙 / 스와로브스키

스와로브스키란?

오스트리아의 크리스탈 기공업체 브랜드로 보석류, 약세사리, 장식용 제품에 쓰이는 고급 크리스탈임.



1244-1 (아존단열 140mm후레임)

244-1 (130mm 알미늄 후레임)

내장도어체크, 매립형힌지 사용 / 알미늄 색상:블랙
전면 와인레드 / 후면 와인레드 / 스와로브스키

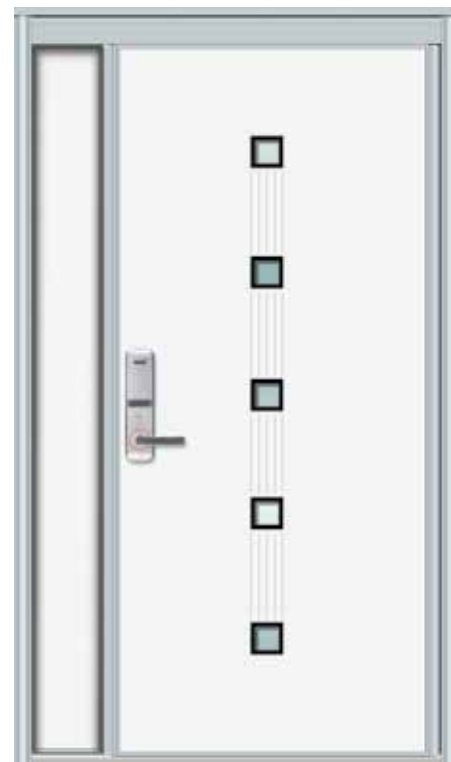

1288 (아존단열 140mm후레임)

288 (130mm 알미늄 후레임)

내장도어체크, 매립형힌지 사용 / 알미늄 색상:실버
전면 화이트 / 후면 화이트

디자인등록 제 30-0833988호

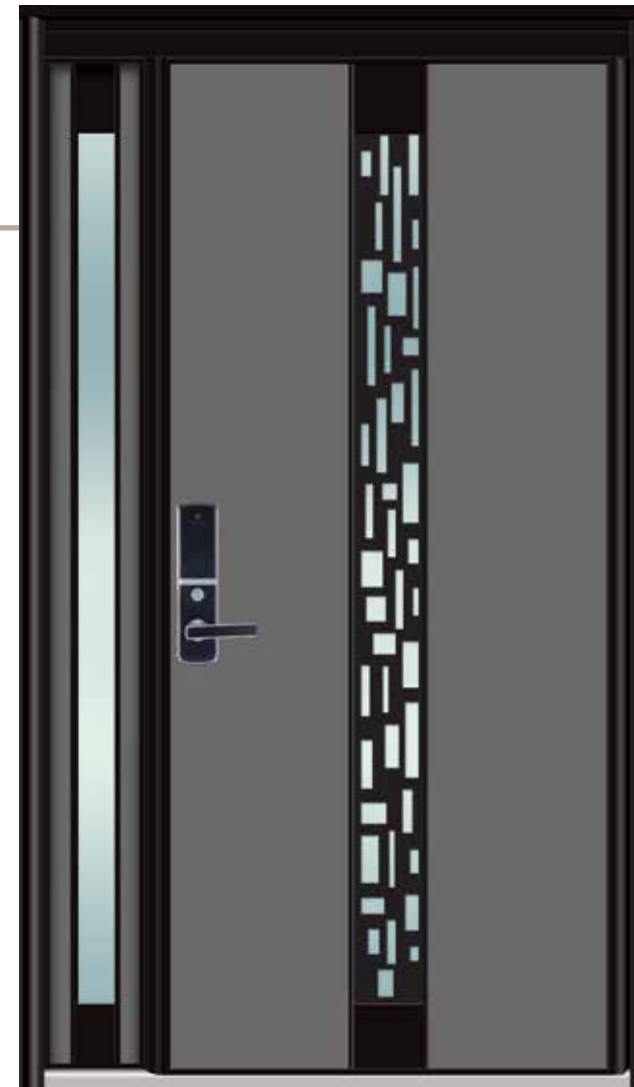

1264 (아존단열 140mm후레임)

264 (130mm 알미늄 후레임)

내장도어체크, 매립형힌지 사용 / 알미늄 색상:블랙
전면 다크그레이 / 후면 다크그레이

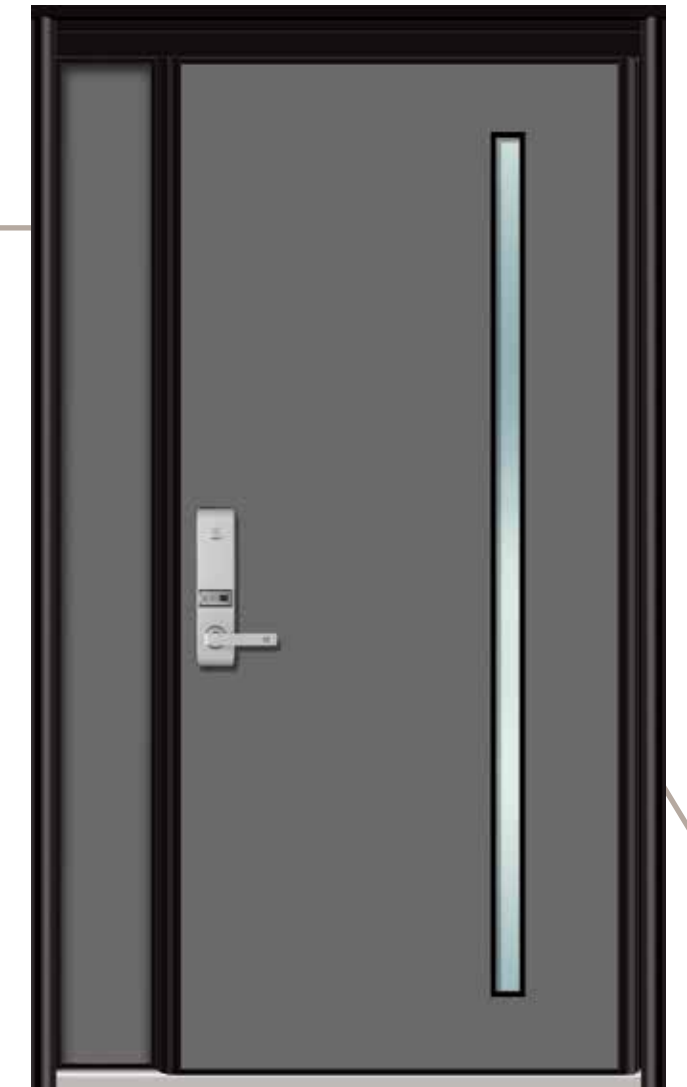

1285 (아존단열 140mm후레임)

285 (130mm 알미늄 후레임)

내장도어체크, 매립형힌지 사용 / 알미늄 색상:블랙
전면 다크그레이 / 후면 다크그레이

Sophisticated Style

세련된 스타일, 패셔너블한 칼라로

모던한 디자인을 추구한 독특한 스타일의 도어입니다.



1267 (아존단열 140mm후레임)

267 (130mm 알미늄 후레임)

내장도어체크, 매립형힌지 사용

알미늄 색상:블랙

전면 버치그레이+그레이라인 / 후면 다크그레이



1263 (아존단열 140mm후레임)

263 (130mm 알미늄 후레임)

내장도어체크, 매립형힌지 사용

알미늄 색상:블랙

전면 버치그레이+라이트월넛 / 후면 다크그레이

Modern Door

투톤칼라의 모던한 스타일에 보석 및 세로 슬릿으로 포인트를 살린제품입니다.

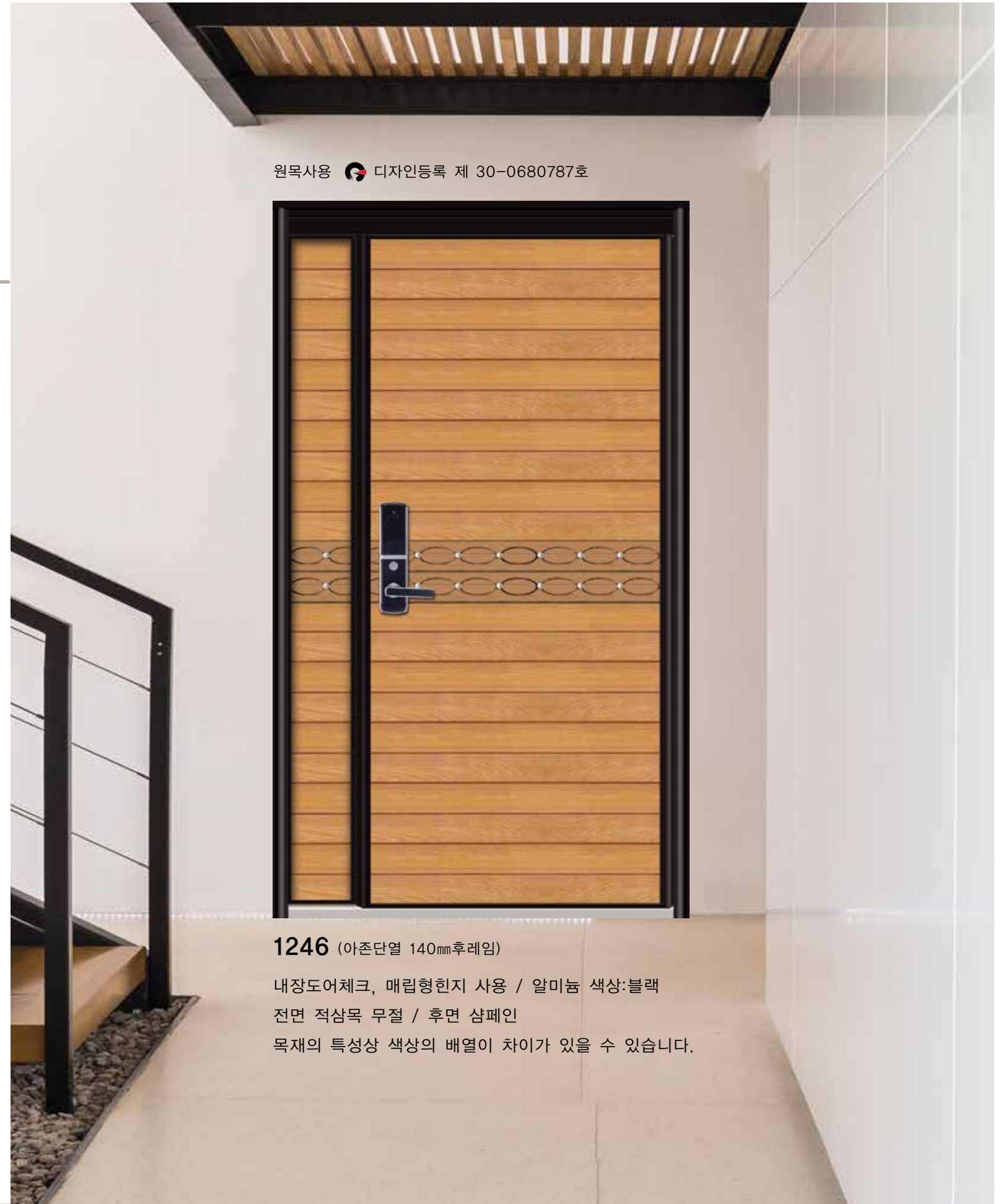

원목사용 디자인등록 제 30-0680787호

1246 (아존단열 140mm후레임)

내장도어체크, 매립형힌지 사용 / 알미늄 색상:블랙

전면 적삼목 무절 / 후면 삼페인

목재의 특성상 색상의 배열이 차이가 있을 수 있습니다.

Nature Beautiful...

From refinement to naturalness.

We bring out the eminence without decorating.

The grace beyond eyeshot and the modern atmosphere will take the place of your level.



1265 (아존단열 140mm후레임)

265 (130mm 알미늄 후레임)

내장도어체크, 매립형힌지 사용

알미늄 색상:실버

전면 버치그레이 / 후면 다크그레이



1245 (아존단열 140mm후레임)

245 (130mm 알미늄 후레임)

내장도어체크, 매립형힌지 사용

알미늄 색상:블랙

전면 그레이라인 / 후면 실버

1310-2

(아존단열 140mm후레임)

310-2

(130mm 알미늄 후레임)

내장도어체크,

매립형힌지 사용

알미늄 색상:블랙

전면 실버 / 후면 실버

1215

(아존단열 140mm후레임)

215

(130mm 알미늄 후레임)

내장도어체크,

매립형힌지 사용

알미늄 색상:블랙

전면 화이트, 삼페인

후면 화이트



Modern Door

세로슬릿 유리에 가로로 포인트를 준 모델로서 모던함과 안정감을 동시에 추구한 디자인의 도어입니다.

디자인등록 제 30-0833986호



1268 (아존단열 140mm후레임)

268 (130mm 알미늄 후레임)
내장도어체크, 매립형힌지 사용 / 알미늄 색상:블랙
전면 라이트월넛 / 후면 샴페인

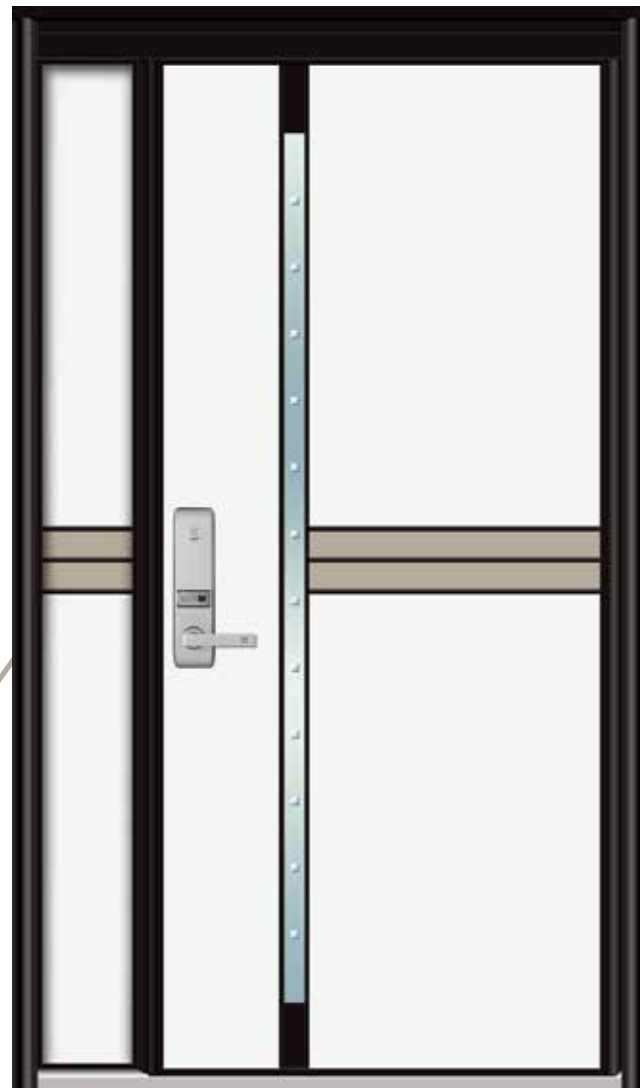

1242 (아존단열 140mm후레임)

242 (130mm 알미늄 후레임)
내장도어체크, 매립형힌지 사용 / 알미늄 색상:블랙
전면 화이트, 샴페인 / 후면 화이트



1251 (아존단열 140mm후레임)

251 (130mm 알미늄 후레임)
내장도어체크, 매립형힌지 사용 / 알미늄 색상:블랙
전면 샴페인 / 후면 샴페인



1254-1 (아존단열 140mm후레임)

254-1 (130mm 알미늄 후레임)
내장도어체크, 매립형힌지 사용
알미늄 색상:실버
전면 화이트 / 후면 화이트



1306-2 (아존단열 140mm후레임)

306-2 (130mm 알미늄 후레임)
내장도어체크, 매립형힌지 사용
알미늄 색상:블랙
전면 실버 / 후면 실버

복합소재를 사용하여 결로를 방지하는

“알루미늄 현관문”

PVC수지 접합도어

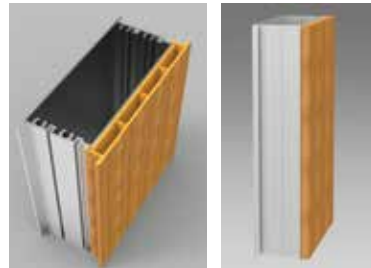

알루미늄에 PVC수지를 접합하여 도어내측의 열전도율을 현저히 낮춤으로써 결로현상을 방지하는 구조.
 도어 외측은 알루미늄으로 알루미늄의 장점인 경량화와 내부식성을 실현하고 내측은 PVC를 사용하여 열전도율을 낮춤으로 알루미늄도어의 최대 단점인 결로현상을 완화한다.



폴리우레탄 단열



폴리아미드 단열



PVC 접합

알루미늄에 PVC수지를 결합하여 도어내측의 열전도율을 현저히 낮춤으로써 결로현상을 억제 하는 구조.

도어의 구조적장점

도어외부(알루미늄)	도어내부(PVC+랩핑)
강도가 우수	낮은 열전도율
경량형 소재	물과 습기에 강함
빛물에 의한 부식방지	미감이 우수
다양한 모양	

트윈 도어의 특징

알루미늄의 장점인 내구성, 경량성과 합성수지의 접합으로 단열성능향상 물이나 습기에 의한 부식이 없다.
 열전도율이 낮은 PVC마감으로 외부의 온도가 전달되지 않아 결로현상 완화.
 (결로방지 효과는 탁월하나 악조건시엔 결로가 생길 수 있습니다.)

조립도 도면

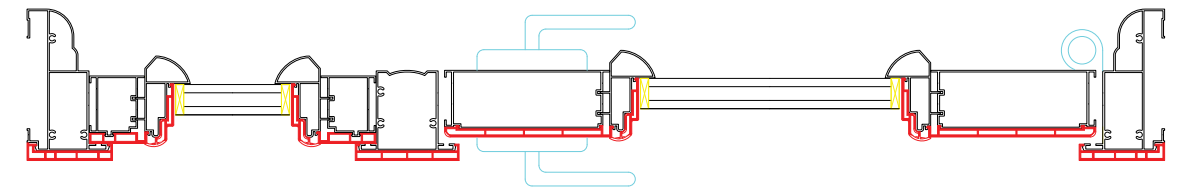

특허 출원중

특허 출원번호:10-2016-0098866

❖발명의 명칭:

현관문 구조 (Exterior Door Assembly)

❖기술분야:

본 발명은 출입을 통제할 수 있도록 집의 출입구에 설치되는 현관문 구조에 관한 것으로서, 특히 금속재의 프레임에 합성수지재의 장식 패널이 설치되어 미감이 향상되고 장식 효과를 높일 수 있도록 한 현관문 구조에 관한 것이다.

Color Chart 칼라차트

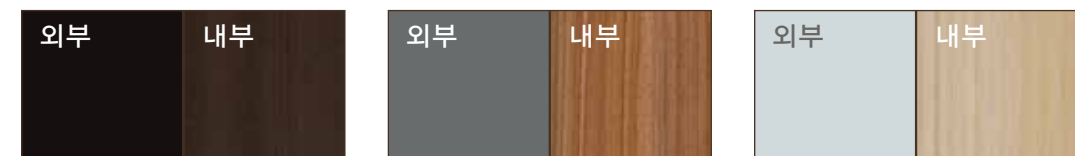



TD 1601 화인

복합소재를 사용하여 결로를 방지하는

“알루미늄 현관문”

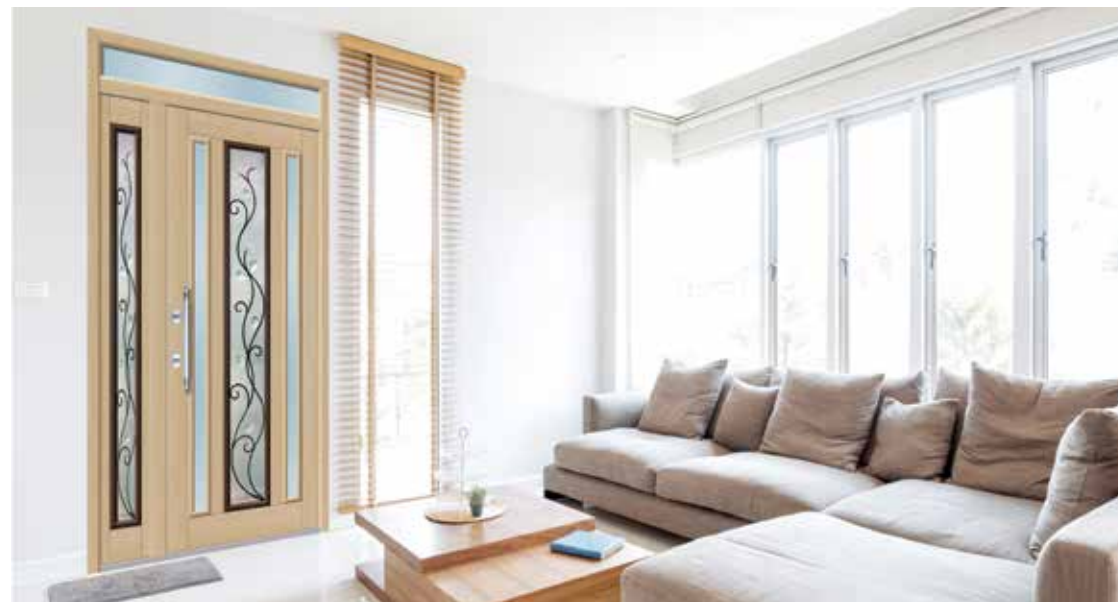

TD 1601 후면

We turn to 'a High quality front door provider
by creating value to grant a new concept for the front door,
by respecting customers specially to offer qualified products and services,
by providing the advanced life styles and high quality products.



TD 1602 블랙+월넛



TD 1602 후면



TD 1603 화인+월넛

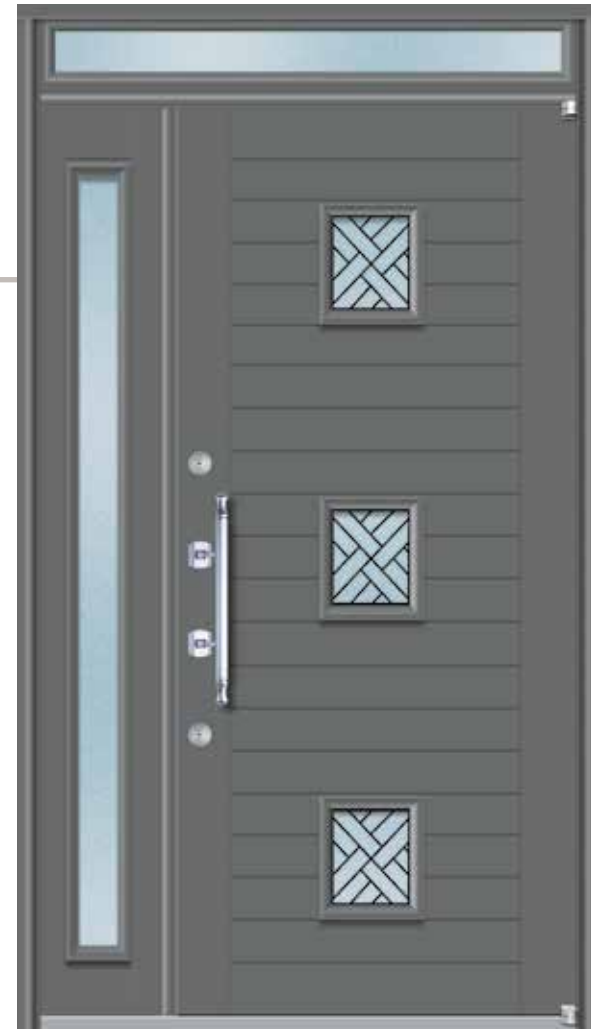

TD 1604 진회색

복합소재를 사용하여 결로를 방지하는

“알루미늄 현관문”

High-quality product to meet all.
Products matching humans and nature!
Products providing d high level of design
matched wel with people.



TD 1603 후면



TD 1604 후면



TD 1605 후면

TD 1605 블랙



TD 1606 블랙+월넛



TD 1606 후면

복합소재를 사용하여 결로를 방지하는 알루미늄 현관문

기술력과 트렌드를 선도하는 아름다운 디자인,
원칙을 지키는 안전한 제품에 이르기까지,
고객의 만족을 위해 열정 가득한 전문가들이 함께 합니다.



TD 1607 블랙



TD 1607 후면

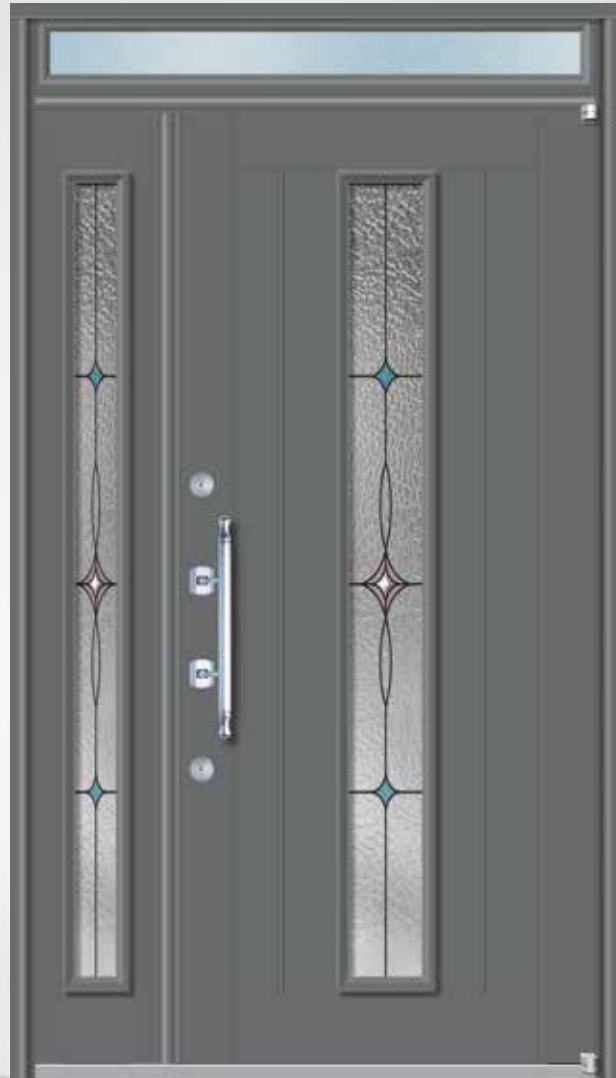

TD 1608 진회색



TD 1609 블랙+진회색

복합소재를 사용하여 결로를 방지하는

“알루미늄 현관문”

Design is directed toward human beings.
To design is to solve human problems by identifying them and executing the best solution.
We are constantly striving for the best.



TD 1608 후면

Key Collection | 키 모음집

		
봉키실버	게이트맨 WS200	게이트아이 MS200B



TD 1609 후면



TD 1610 화인+월넛

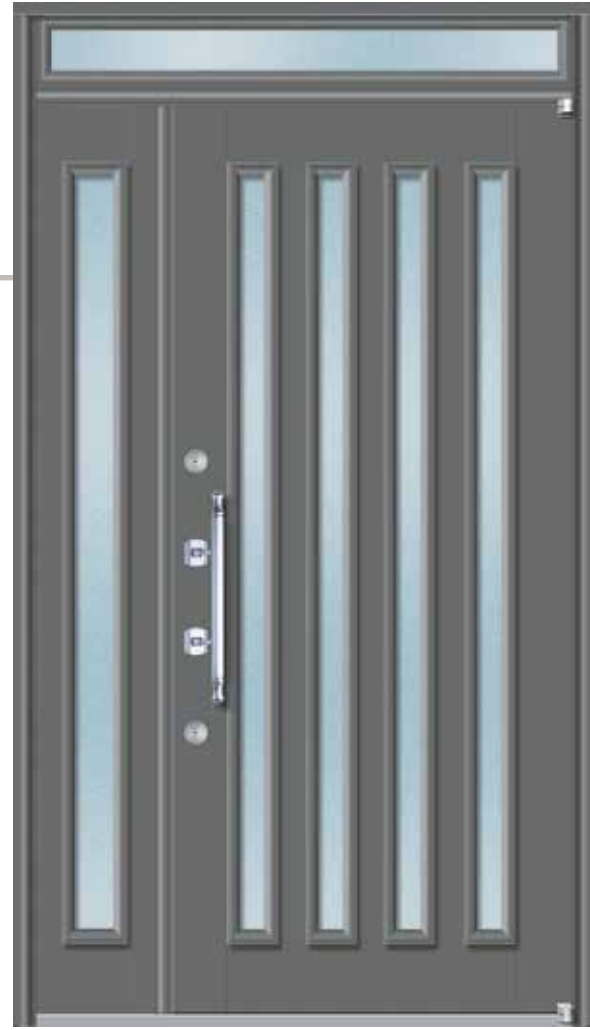

TD 1611 진회색



TD 1612 후면



TD 1612 화인

복합소재를 사용하여 결로를 방지하는

“알루미늄 현관문”

High-quality product to meet all.
Products matching humans and nature!
Products providing a high level of design
matched well with people.



TD 1610 후면



TD 1611 후면



TD 1613 후면



TD 1613 블랙+월넛

General Door | 일반도어

알루미늄 프로파일을 조립하여 디자인한 베이직 도어로 알루미늄 사이에 유리 또는 주물이 들어가 있는 도어입니다.

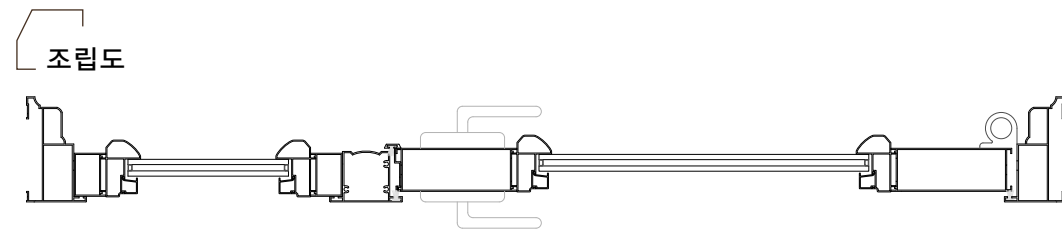

돌출도어체크



돌출도어힌지



봉키(기본)



매립형도어체크(선택)

Key Collection | 키 모음집

봉키실버	삼성푸쉬록 D710	게이트맨 WS200	게이트아이	볼트	미니봉키



801

돌출도어체크, 피봇트 힌지
알미늄 색상:레드, 유리+렉산

General Door

Design is directed toward human beings.
To design is to solve human problems by identifying them and executing the best solution.
We are constantly striving for the best.

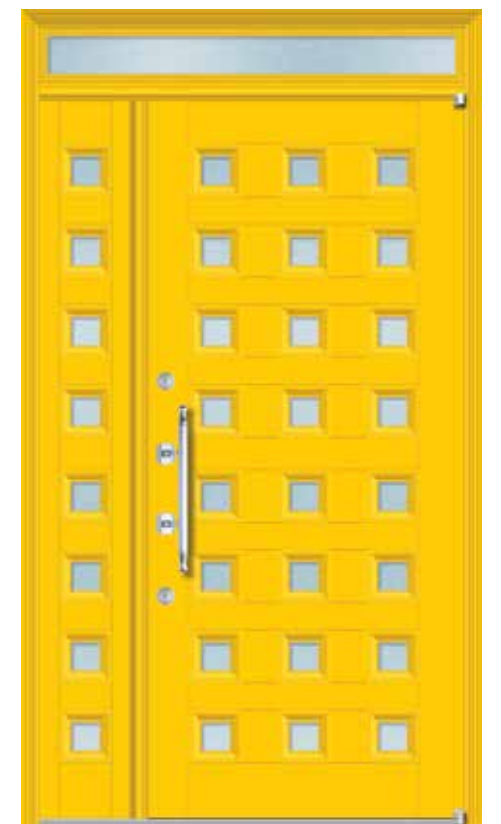

802

돌출도어체크, 피봇트 힌지
알미늄 색상:옐로우, 유리+렉산



803

돌출도어체크, 피봇트 힌지
알미늄 색상:화이트, 블랙 / 목단조페어유리, 후면렉산



804

돌출도어체크, 피봇트 힌지
알미늄 색상:월넛, 유리+렉산

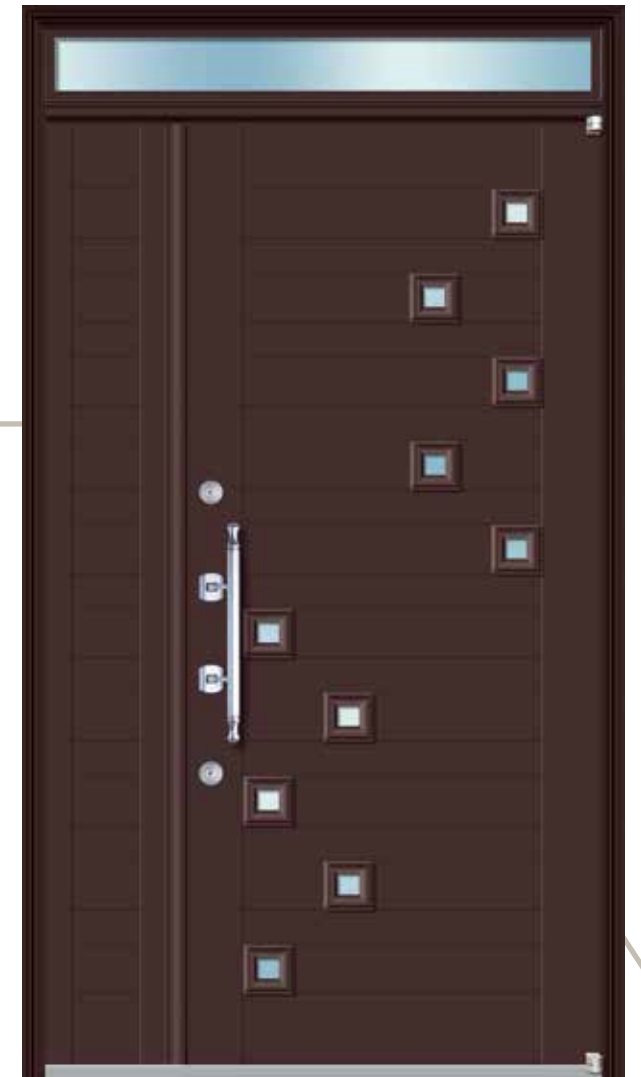

805

돌출도어체크, 피봇트 힌지
알미늄 색상:초콜릿, 유리+렉산

Best Collection of Front Door

We turn to 'a High quality front door provider
by creating value to grant a new concept for the front door,
by respecting customers specially to offer qualified products and services,
by providing the advanced life styles and high quality products.

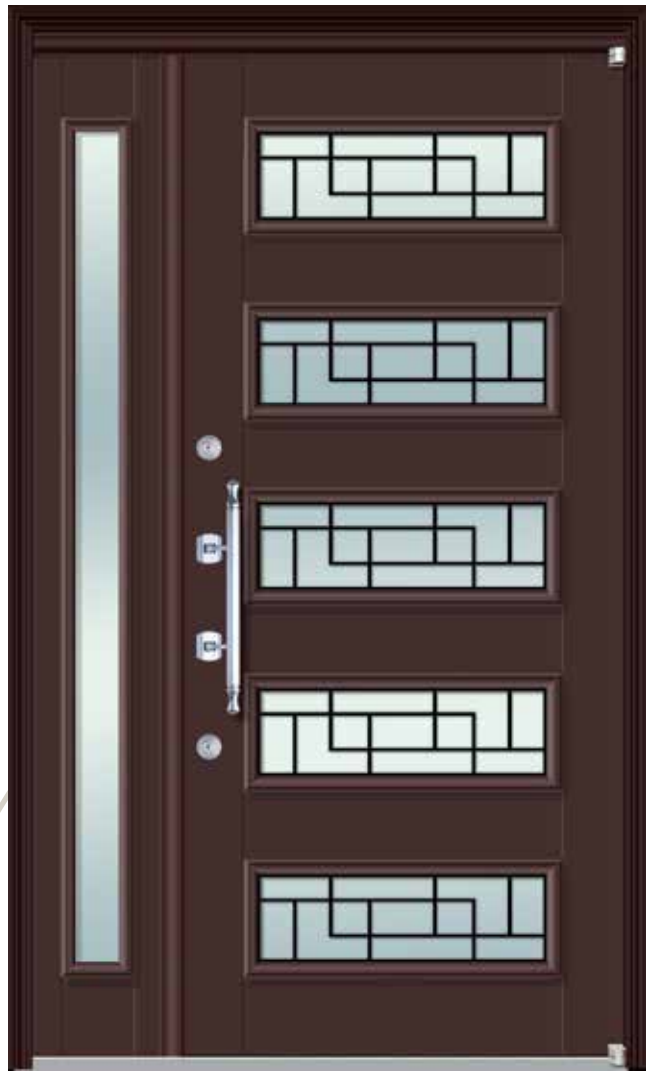

806

돌출도어체크, 피벗트 힌지
알미늄 색상:초콜릿, 목단조 페어유리
후면렉산



807

돌출도어체크, 피벗트 힌지
알미늄 색상:블랙, 초콜릿, 격자 페어유리
후면렉산

808

돌출도어체크
피벗트 힌지
알미늄 색상:화이트
목단조 페어유리, 후면렉산



General Door

기술력과 트렌드를 선도하는 아름다운 디자인,
원칙을 지키는 안전한 제품에 이르기까지,
고객의 만족을 위해 열정 가득한 전문가들이 함께 합니다.

809

돌출도어체크
피벗트 힌지
알미늄 색상:초콜릿, 화이트
목단조 페어유리
후면렉산



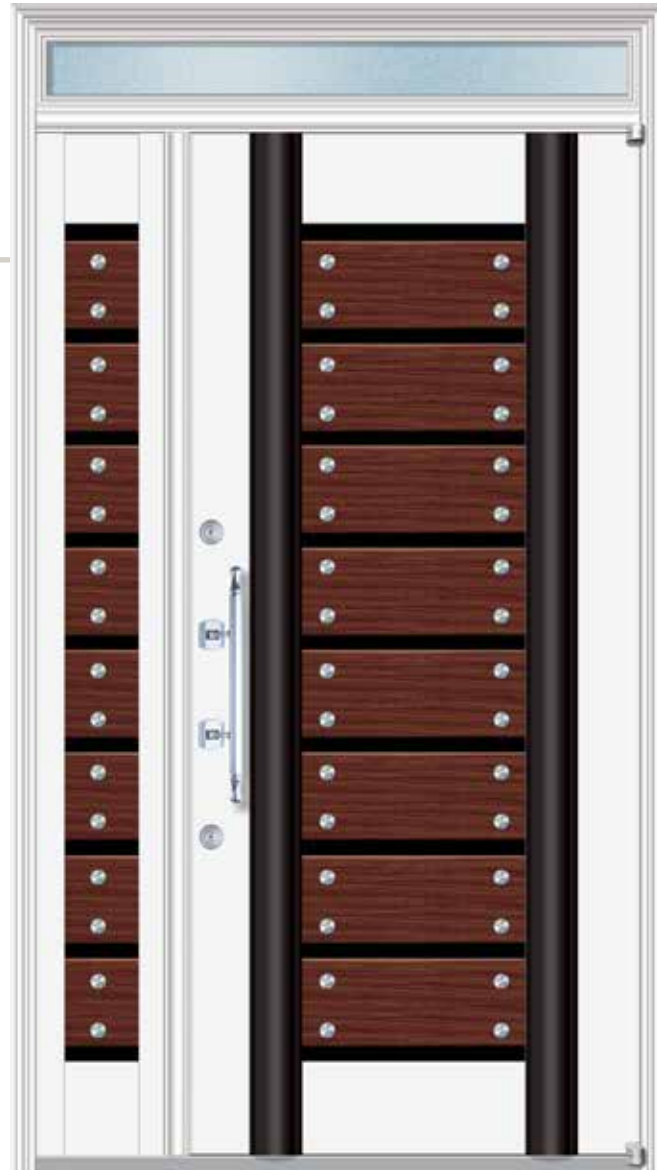

810

돌출도어체크, 피벗트 힌지
알미늄 색상:화인, 월넛, 알미늄장식볼

811

돌출도어체크, 피벗트 힌지
알미늄 색상:화이트, 월넛, 알미늄장식볼

High-quality product meet all

고객의 만족을 위해 열정 가득한 전문가들이 함께 합니다.
사고 싶은 제품, 가지고 싶은 제품!



812

돌출도어체크, 피벗트 힌지
알미늄 색상:화인, 아쿠아유리, 알미늄장식볼



813

돌출도어체크, 피봇트 힌지
알미늄 색상:블랙, 월넛, 목단조 페어유리, 후면렉산



814

돌출도어체크, 피봇트 힌지
알미늄 색상:화이트
목단조 페어유리, 후면렉산



815

돌출도어체크, 피봇트 힌지
알미늄 색상:화이트
유리+렉산

Key
Collection | 키 모음집

					
봉키실버	삼성푸쉬폴 D710	게이트맨 WS200	게이트아이	볼트	미니봉키

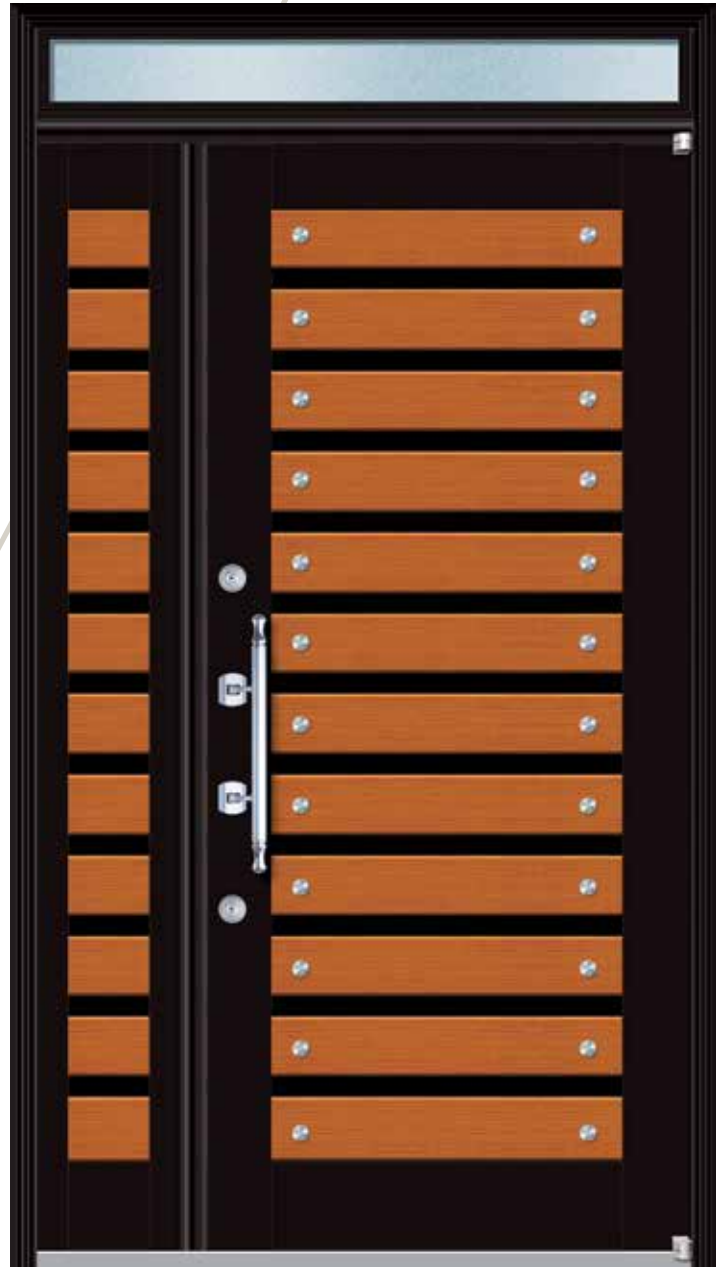

816
돌출도어체크, 피봇트 힌지
알미늄 색상:블랙, 체리, 알미늄 장식볼



817
돌출도어체크, 피봇트 힌지
알미늄 색상:블랙, 월넛, 알미늄 장식볼



818
돌출도어체크, 피봇트 힌지
알미늄 색상:화인, 월넛, 알미늄 장식볼



819
돌출도어체크, 피봇트 힌지
알미늄 색상:블랙, 초콜릿, 격자 페어유리, 후면렉산



820
돌출도어체크, 피봇트 힌지
알미늄 색상:블랙, 격자 페어유리, 후면렉산



821
돌출도어체크, 피봇트 힌지
알미늄 색상:화이트, 격자페어유리, 후면렉산



822
돌출도어체크, 피봇트 힌지
알미늄 색상:화이트, 보석유리, 후면렉산

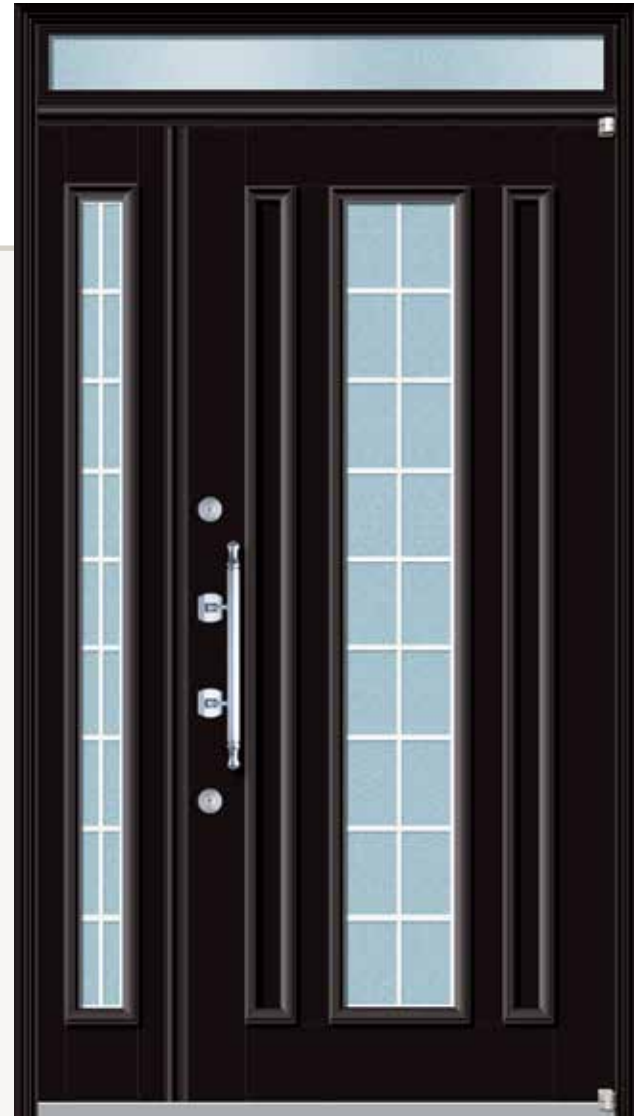

823
돌출도어체크, 피봇트 힌지
알미늄 색상:블랙, 격자 페어유리, 후면렉산



824
돌출도어체크, 피봇트 힌지
알미늄 색상:화이트, 보석유리, 후면렉산



825 돌출도어체크, 피봇트 힌지
알미늄 색상:월넛, 보석유리, 후면렉산



826 돌출도어체크, 피봇트 힌지
알미늄 색상:화이트, 격자 페어유리,
후면렉산, 알미늄 주물판넬

General Door

Design is directed toward human beings.

To design is to solve human problems by identifying them and executing the best solution.

We are constantly striving for the best.

기술력과 트렌드를 선도하는 아름다운 디자인,
원칙을 지키는 안전한 제품에 이르기까지,
고객의 만족을 위해 열정 가득한 전문가들이 함께 합니다.



827
돌출도어체크, 피봇트 힌지
알미늄 색상:화이트, 유리+렉산



828
돌출도어체크, 피봇트 힌지
알미늄 색상:화인, 유리+렉산



829
돌출도어체크, 피봇트 힌지
알미늄 색상:블랙, 유리+렉산



830 돌출도어체크, 피봇트 힌지
알미늄 색상:블랙, 유리+렉산



831
돌출도어체크, 피봇트 힌지
알미늄 색상:화이트, 유리+렉산



832
돌출도어체크, 피봇트 힌지
알미늄 색상:화인

Key Collection | 키 모음집

		
봉키실버	삼성푸쉬록 D710	게이트맨 WS200
		
게이트아이	볼트	미니봉키



833 돌출도어체크, 피봇트 힌지
알미늄 색상:화인, 아쿠아유리



836 돌출도어체크, 피봇트 힌지
알미늄 색상:화인, 유리+렉산



837 돌출도어체크, 피봇트 힌지
알미늄 색상:월넛, 유리+렉산



834 돌출도어체크, 피봇트 힌지
알미늄 색상:블랙, 아쿠아유리



835 돌출도어체크, 피봇트 힌지
알미늄 색상:화이트, 아쿠아유리



838 돌출도어체크, 피봇트 힌지
알미늄 색상:화이트, 격자 페어유리, 후면렉산



839 돌출도어체크, 피봇트 힌지
알미늄 색상:화이트, 유리+렉산

General Door

기술력과 트렌드를 선도하는 아름다운 디자인,
원칙을 지키는 안전한 제품에 이르기까지,
고객의 만족을 위해 열정 가득한 전문가들이 함께 합니다.

1014 화인



Front Door

We turn to 'a High quality front door provider
by creating value to grant a new concept for the
front door,
by respecting customers specially to offer qualified
products and services,
by providing the advanced life styles and high qual-
ity products.



대나무-1 화인



7005 월넛



2010 블랙



국화-1 화이트



9210 월넛



9211-1 화이트



9211 블랙



9214 화인

High-quality product meet all

Design is directed toward human beings.

To design is to solve human problems by identifying them and executing the best solution.

We are constantly striving for the best.



9216-1 화인



9216 블랙

Folding Door | 폴딩도어

폴딩도어는 접이식구조의 슬라이딩도어로서 공간 확장에 매우 효과적인 제품입니다. 또한 E.D.P.M gasket을 2중으로 적용하여 기존 폴딩도어의 단점이었던 기밀성능을 대폭 향상시켰습니다.

특장점

1. 기능성:90%이상의 개폐율을 보장하여 확장 기능은 물론 공간활용이 우수합니다.
2. 활용성:개폐로 인하여 접근성이 용이하여 상업공간으로서 자연스럽게 구매력을 증가시킵니다.
3. 디자인:다양한 색상과 깔끔한 디자인으로 격조높은 공간을 연출합니다.
4. 내구성:부식에 강한 알루미늄 폴딩도어로서 반영구적 사용이 가능합니다.



폴딩도어 개폐방식

1way(한쪽방향)

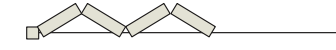

좌측 혹은 우측방향에 고정하여 한쪽으로 열리는 타입입니다. 가장 기본적으로 쓰이는 방식이며 넓이 5000mm이하에 주로 쓰입니다.

2way(양쪽방향)



좌측과 우측을 모두 고정하여 양쪽으로 열고 닫을 때 쓰이는 타입입니다. 설치 할 장소가 넓은 경우에 많이 쓰이는 타입입니다.

1way+Door(한쪽방향+고정문)

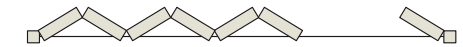

1way 타입에 주 출입문을 별도로 설치한 타입입니다. 따로 출입문이 없는 경우 또는 폴딩도어를 열지 않고 출입을 원할 때 쓰이는 타입입니다. (경첩형 고정문=90도 열림, 수입레바키 사용) (힌지용 고정문=180도 열림, 플로어힌지 사용, 강화도어 핸들과 보조키사용)



플러스 폴딩도어는?



손 끼임최소화

문짝과 문짝사이의 가스켓 폭을 18mm로 하여 개폐시 손 끼임으로 인한 부상을 최소화 하였습니다.



모헤어

문짝 하부 모헤어 중간에 부직포가 포함된 핀모헤어 사용으로 외기 유입 차단에 효과적입니다.



짝수도어 개폐방식



홀수도어 개폐방식



프레임

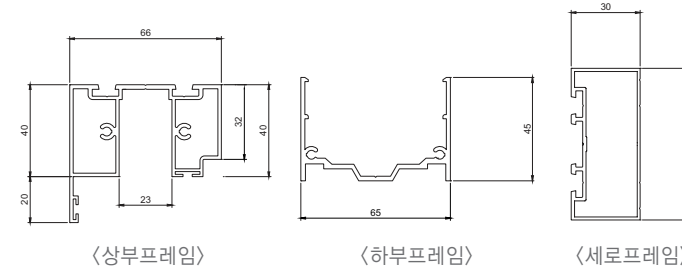

폴딩도어 레일

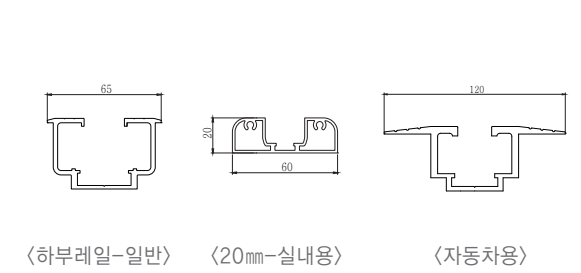

단열 폴딩도어

Insulated Folding Door

알루미늄 프로파일 중간에 열전도를 차단하는 Polyamide를 삽입한 도어로 열전도에 의한 에너지 손실 및 결로를 줄어줍니다.

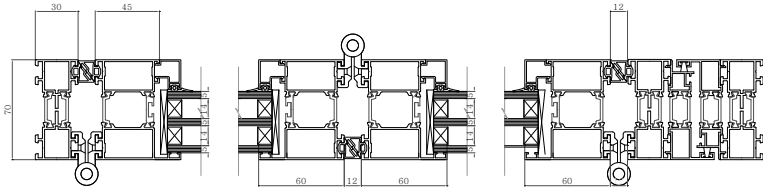

• 수평단면 상세도

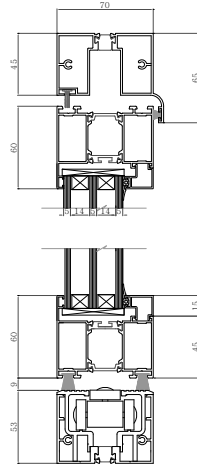

• 수직단면 상세도

Frame 프레임

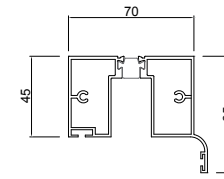

<상부프레임>

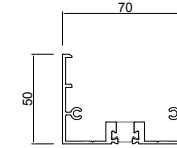

<하부프레임>

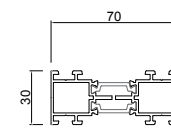

<세로프레임>

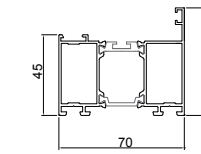

<문짝바>



• 열관류율 1.36, 기밀1 등급(43T유리)



폴딩도어 구동방식

• 하부 구동방식(하부지지형)

다용도로 사용되는 가장 일반적인 방식입니다. 하부 롤러로 구동이 되고 하부에 하중을 받게 됩니다.

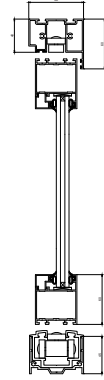

• 상부 구동방식(상부지지형)

하부에 부득이하게 레일을 매립하지 못하는 경우 상부에 구동 롤러를 적용하여 모든힘을 받도록 하는 방식입니다.

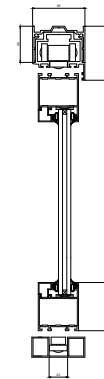

• 상하부 구동방식(상하부지지형)

문짝의 중량이 많은 경우 또는 문짝이 후레임과 고정 없이 움직이는 Freeway 방식의 경우 상하부에 롤러를 달아 문이 넘어지지 않도록 합니다.

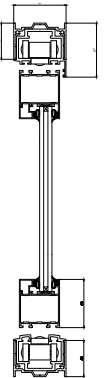

폴딩방충망

지정된 색상 이외의 색은 알루미늄 도장으로 가능합니다. (도장비 별도)

※방충망 높이 3000mm까지 가능합니다.



Best of
Plus Door

Collection of System Door | 시스템 도어

System Door | 시스템 도어

유럽식 시스템도어가 향상된 단열, 기밀성능으로 건물의 에너지절감 효과를 높여 드립니다.



• 특 징

1. 알루미늄의 견고한 재질과 뛰어난 내구성은 유지하고 폴리아미드 결합으로 단열성능을 높였습니다.
2. EDPM gasket의 사용으로 단열 및 기밀성, 수밀성능을 높였습니다.
3. 독일 Dr. Hann사의 고급힌지 사용으로 부드럽게 열고 닫힙니다.
4. 매립형 도어체크를 사용하여 더욱 깔끔한 외관을 연출합니다.(선택사양)

• 시스템도어 구조

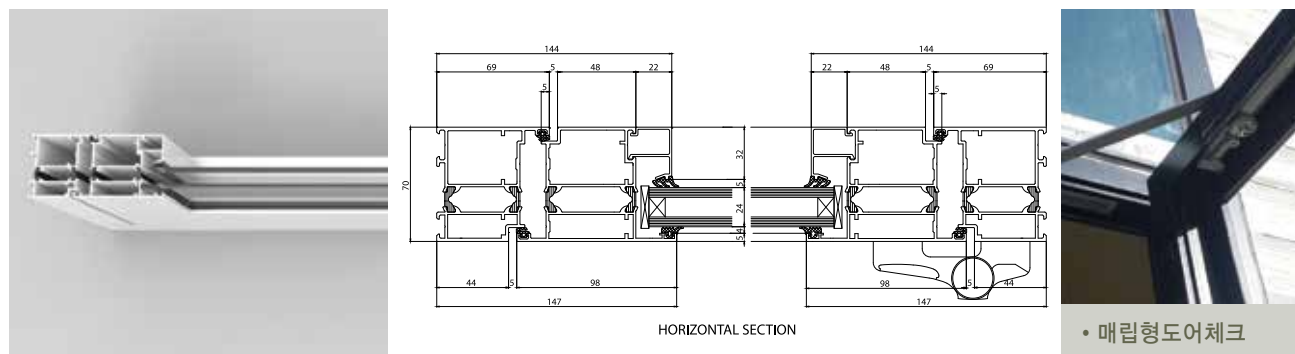

Slim interior door for your modern life style

슬림한 디자인의 슬라이딩 도어는 공간을 시각적으로 더욱 넓어 보이게 함과 동시에 공간을 구분하여 효과적으로 사용할 수 있게 해주며, 실내 인테리어에 포인트를 주어 분위기 변화에 효과적인 아이템입니다. 검증된 댄퍼 시스템을 이중으로 장착하여 손 기임에 의한 사고를 방지할 수 있으며, 소음감소 및 열의 이동을 차단하여 냉난방비의 절감 효과가 탁월 합니다.

Design type

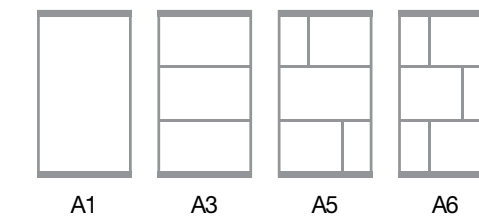

4 linked Slim Sliding Door | 슬림 4연동 도어



아쿠아 4연동



망입
4연동



브론즈
4연동



까르띠에
· 유니크퓨징유리(5T)
· 옵션 : 브론즈유리

Silm 3 Interlink Door 슬림 3연동도어

고급스러운 브론즈 유리로 은은하면서 심플한 느낌을 더 했습니다.

문짝 가로바 부분을 슬림하게 하여 미관이 보다 더 세련되어 보이도록 마감했습니다.



요즘 트렌드에 맞춰 문짝을 슬림화하여 개방감을 높였습니다.

슬림형 3연동

Silm 3 Interlink Door

우수한 제품으로 고객여러분의 성원에 보답하고자 배전의 노력을 기울이고 있습니다.
보다 더 세련되고 심플한 디자인으로 한층 더 고퀄리티를 보여드리도록 하겠습니다.

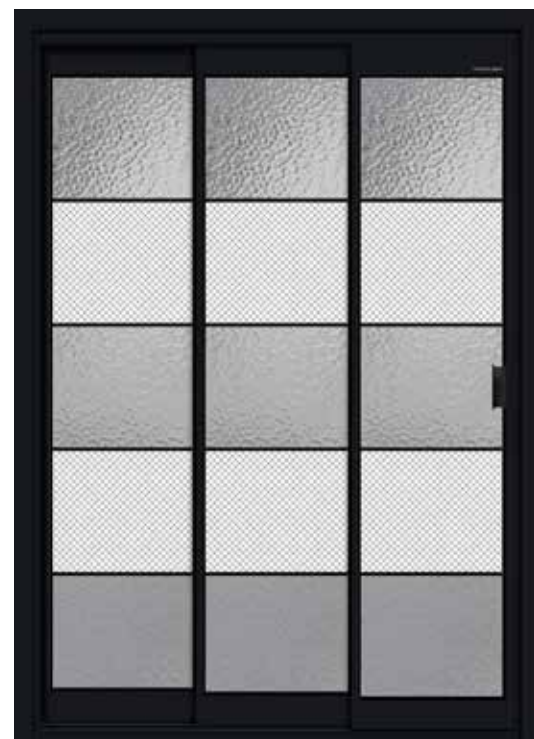

아쿠아+망입



아쿠아



6039 3연동



블랙 플라워 3연동



아르누보 3연동



6030 3연동

Life,
Human & Nature
Design

3 Interlink
Inner Door



6028
3연동

3 Interlink Inner Door | 3연동



가로등 3연동



어린왕자
3연동



웨딩
3연동



Nature Beautiful...

From retinement to naturalness.
We bring out the eminence without decorating.
The grace beyond eyeshot and the modern atmosphere
will take the place of your level.

주작
3연동



제노아 3연동



큐브 3연동



나뭇잎 3연동



자목련 3연동



판타지 3연동

Life,
Human & Nature
Design



픽
6연동

3 Interlink Inner Door



포르테 3연동



주얼리 3연동



별자리 3연동



망입 3연동



Nature Beautiful...

From retinement to naturalness.
We bring out the eminence without decorating.
The grace beyond eyeshot and the modern atmosphere
will take the place of your level.

오리엔탈 3연동



콰트로 3연동



고시망입 3연동

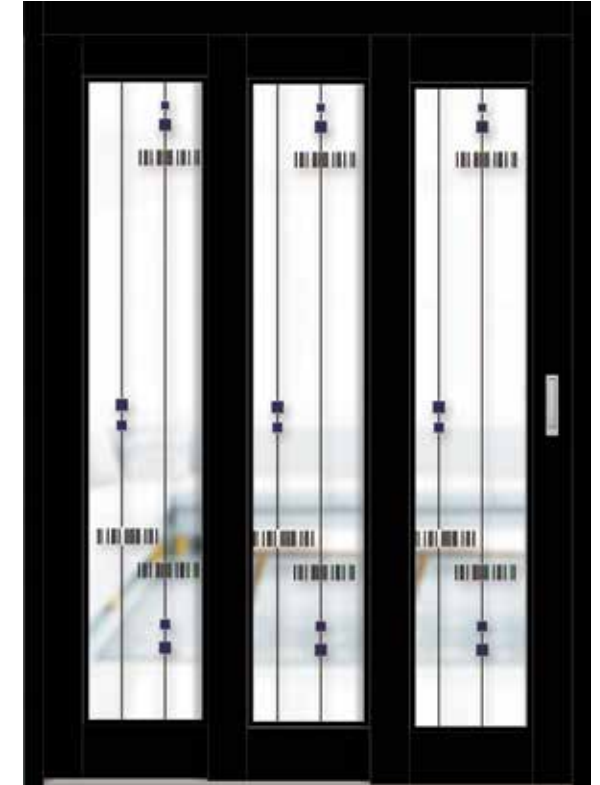

YJ-29 3연동



워터큐브 3연동



제노아



스윙도어
Swing
Door

Life,
Human & Nature
Design

주작



로리타



망입



7043

W1500XH2130
(한지시공높이 1815)
쪽문가능, 기동별매



7076

W1200XH1855
(한지시공높이 1795)
쪽문가능



7026

대:W1500XH1750(한지시공높이 1660), 쪽문불가, 기동별매
소:W1500XH1550(한지시공높이 1450), 쪽문불가, 기동별매



7044

W1500XH2000(한지시공높이 1900), 쪽문가능, 기동별매



7075(대) W1000XH2000(한지시공높이 1900), 쪽문가능



7064 대:W1500XH2080(한지시공높이 1710), 쪽문가능, 기동별매
중:W1500XH1800(한지시공높이 1610), 쪽문가능, 기동별매



7075(소) W1000XH1500(한지시공높이 1400), 쪽문불가



7064(소) W1500XH1500(한지시공높이 1310), 쪽문불가
일자형:W790XH1270(한지시공높이 1310)



7065 대:W1200XH2050(한지시공높이 1800), 쪽문가능, 기동별매
중:W1200XH1800(한지시공높이 1550), 쪽문가능, 기동별매
일자형:W1000XH1750(한지시공높이 1810)



7066(대) W1370XH2100(한지시공높이 1830), 쪽문가능, 기동별매



7065(소) W1200XH1470(한지시공높이 1220), 쪽문불가
일자형:W1000XH1150(한지시공높이 1220)

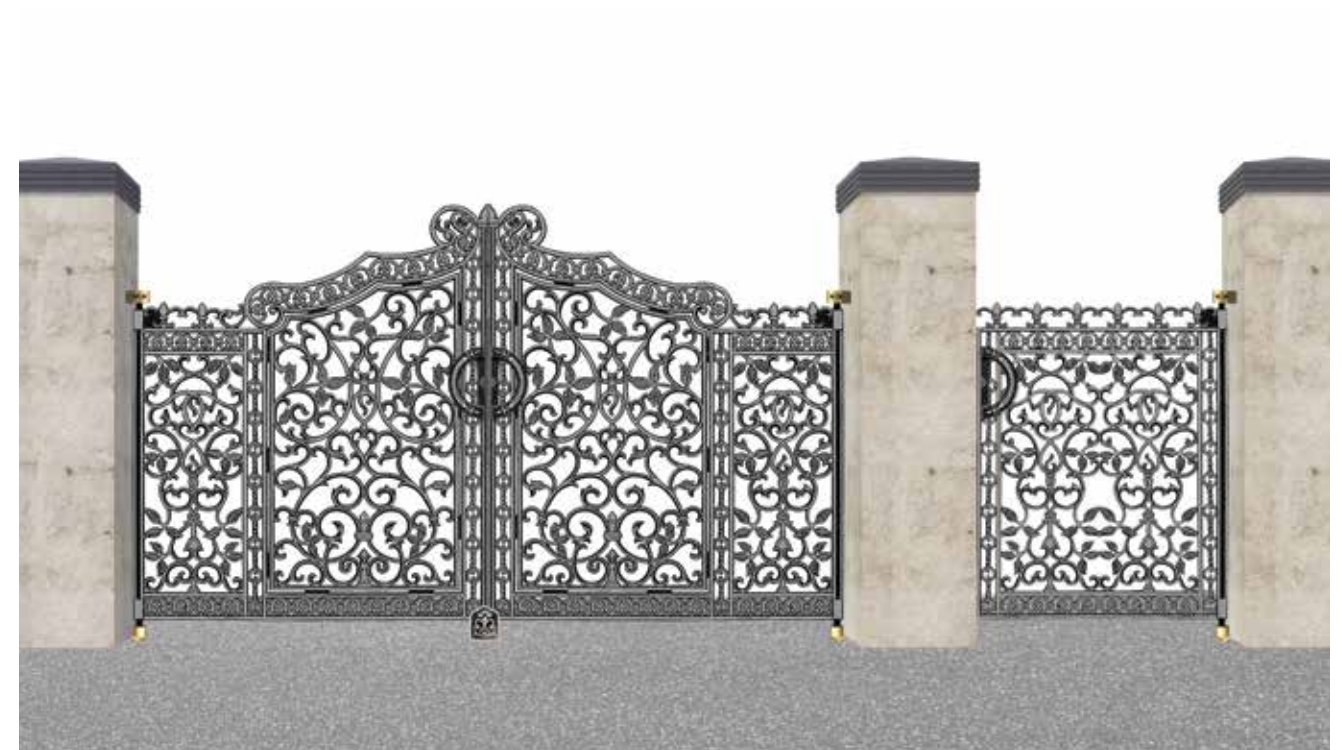

7066(소) W1370XH1610(한지시공높이 1340), 쪽문불가

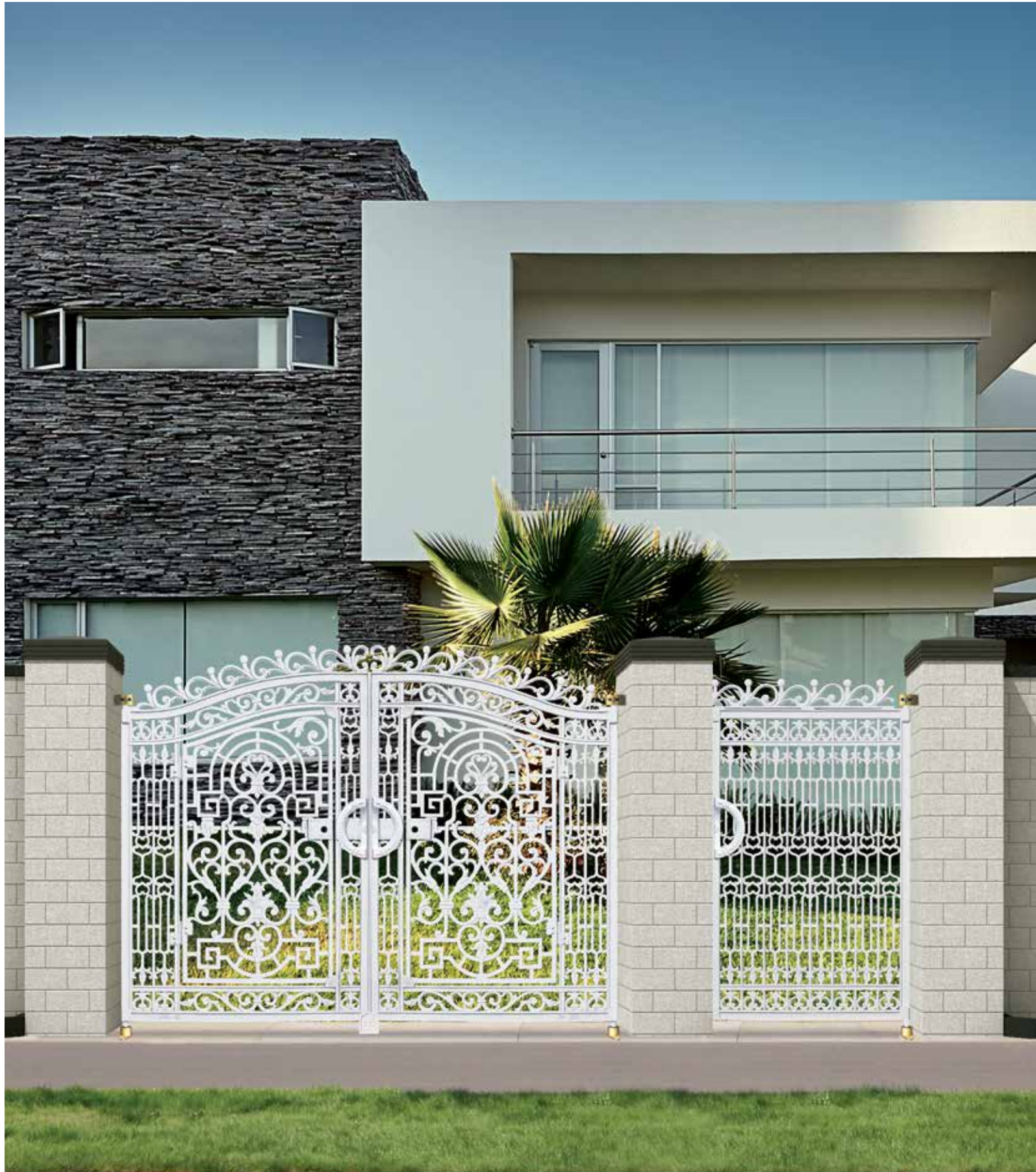

7067 W1200XH1800(한지시공높이 1650), 쪽문가능 / 일자형:W1000XH1630(한지시공높이 1650)



몽마르뜨 대:W1200XH2000(한지시공높이 1780), 쪽문가능, 기동별매
중:W1200XH1800(한지시공높이 1580), 쪽문가능, 기동별매



7022 W1500XH1500(한지시공높이 1220), 쪽문불가, 기동별매 / 일자형:W1200XH1230(한지시공높이 1210)



7034(대) W1200XH2125(한지시공높이 2000), 쪽문가능

7068 대:W1200XH2090(한지시공높이 1820), 쪽문가능 / 일자형:W1000XH1795(한지시공높이 1795)
중:W1200XH1800(한지시공높이 1550), 쪽문가능 / 일자형:W1000XH1550(한지시공높이 1550)



7034(중), (소) 중:W1200XH1780(한지시공높이 1650), 쪽문가능, 기동별매
소:W1200XH1500(한지시공높이 1350), 쪽문가능, 기동별매

7068(소)
W1200XH1430
(한지시공높이 1165), 쪽문불가

일자형:
W1000XH1170
(한지시공높이 1165)





7024(중) W1500XH1800(한지시공높이 1500), 쪽문가능



7014 W1200XH2100(한지시공높이 1890), 쪽문가능, 기동별매



7024(소) W1500XH1500(한지시공높이 1190), 쪽문가능



7019 W1200XH1380(한지시공높이 1220), 쪽문불가, 기동별매



7069
W1530XH1350
(한지시공높이 1260)
쪽문불가



7076
W1530XH1350
(한지시공높이 1260)
쪽문불가



7021
W1500XH1300
(한지시공높이 1250)
쪽문불가



7074 W1500XH1350(한지시공높이 1300), 쪽문불가, 기동별매



7078 아치형:W1205XH1620(한지시공높이 1330)
일자형:W1175XH1195(한지시공높이 1330)

Best of Plus Door

Collection of Assembly Gate | 조립대문



3324 모카브라운

디자인등록 출원번호 제 30-2018-0025091호

3324 Assembly Color Chart | 조립대문

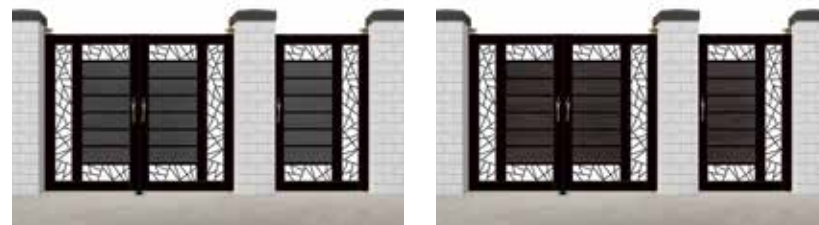

3324 BG(버치그레이)

3324 DO(다크오크)



3324 LW(라이트월넛)

3324 SM(소프트메이플)

High-quality product to meet all.
Products matching humans and nature!
Products providing d high level of de-
sign matched wel with people.

Assembly Gate
조립대문

3325 Assembly Color Chart | 조립대문



3325 LW(라이트월넛)

3325 MB(모카브라운)

3325 DO(다크오크)

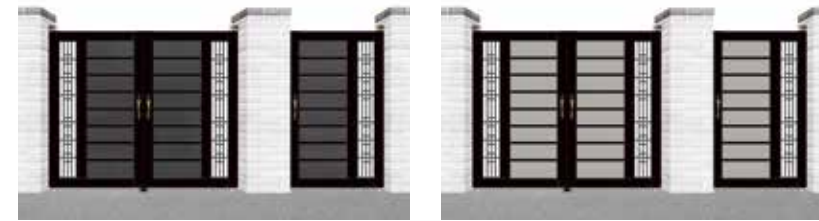

3325 BG(버치그레이)

3325 GL(그레이라인)



3325 베이직티크



3326 다크오크



3327 버치그레이

3326 Assembly Color Chart | 조립대문



3326 SM(소프트메이플)

3326 MB(모카브라운)

3326 LW(라이트월넛)



3326 DS(다크서스)

3326 BT(베이직티크)

3326 BG(버치그레이)

3327 Assembly Color Chart | 조립대문



3327 BT(베이직티크)

3327 DO(다크오크)

3327 LW(라이트월넛)



3327 MB(모카브라운)

3327 SM(소프트메이플)



3321 조립대문



3308 조립대문



3322 조립대문



3320 조립대문



3315 조립대문



3323 조립대문



3317 조립대문



3316 조립대문



3305 조립대문



3403 슬라이딩 조립대문

High-quality product to meet all.
Products matching humans and nature!
Products providing d high level of design
matched wel with people.



3306 조립대문



슬라이딩 자동모터



3402 슬라이딩 조립대문

무레일 알루미늄 대문 자바라

제품특징

1. 알루미늄이나 스텐레스 소재로서 반영구적이며, 다양한 칼라를 지정 할 수 있는 장점.
2. 레일 작업없이 논레일게이트를 설치 할 수 있어 공사비 절감과 인건비를 최소 할 수 있다.
3. 논레일 OPERATER를 설치하여 무인자동화시스템을 구축 할 수 있다.
또한 안전센서를 부착하여 차량 및 사람 출입시 안전성을 갖출 수 있다.
4. 차량이 빈번한 장소, 물류, 대형마트, 선박, 조선등의 중량물 차량 통행 장소에 설치하여 레일의 덜컹거림이없도록 고안하였다.
5. 장애우시설, 노인복지시설, 어린이 보호구역시설등에 설치하여 통행의 불편함을 해소 하였다.

기본치수

• W560×H1200 / W560×H1500(규격외 사이즈 제작가능)



모델명 / KOCOS 3328 / ○○○ 아파트내 무레일대문자바라

스텐 대문 자바라

특장점

- 1.방범 효과가 뛰어납니다.
- 2.외관이 미려하고 산뜻합니다.
- 3.부드럽게 열고 닫힙니다.
- 4.소재가 스텐레스 및 알루미늄이므로 부식이 없어 반영구적입니다.
- 5.신축건물인 경우 벽속에 설치하면 편리합니다.

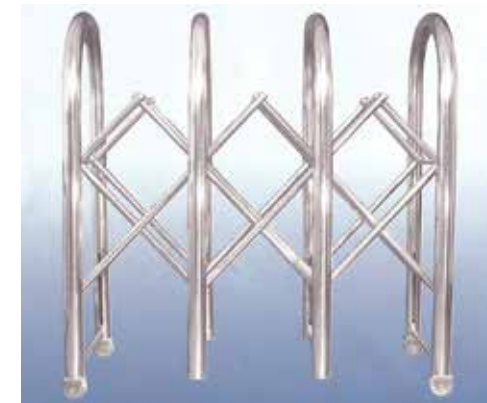

500

- 모델 : 일반자바라
- 재질 : 스텐
- 자재구성
 - 50.8Ø
 - 25.4Ø
 - 15.8Ø
 - 19.1Ø
 - 63Ø(바퀴)



500

- 모델 : 일반자바라
- 재질 : 스텐
- 자재구성
 - 50.8Ø
 - 25.4Ø
 - 15.8Ø
 - 19.1Ø
 - 63Ø(바퀴)



스텐거푸집



스텐레일바퀴



우레탄 바퀴



P 672 W715XH715



P 673
大:W910XH607XT11, 中:W920XH500

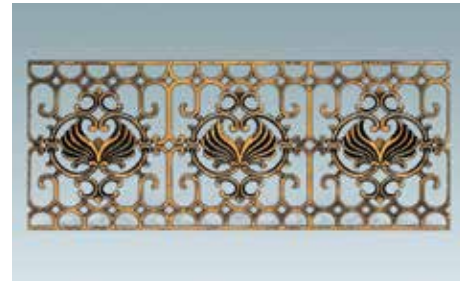

P 673
小:W1010XH400XT10



P 674A W1000XH600

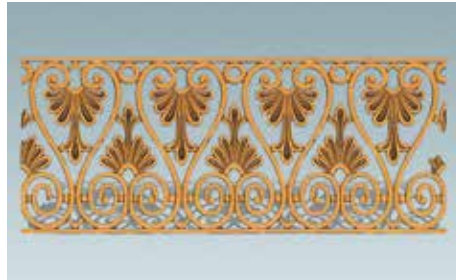

P 674B W1000XH425



P 675 W715XH340XT10

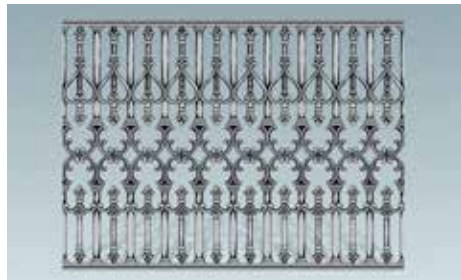

P 676 W1030XH760XT13



P 677 W710XH835



P 678A W1000XH500XT10

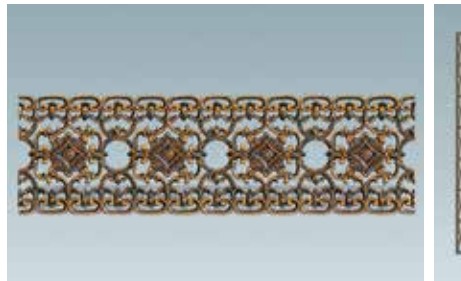

P 678B W1000XH300XT10

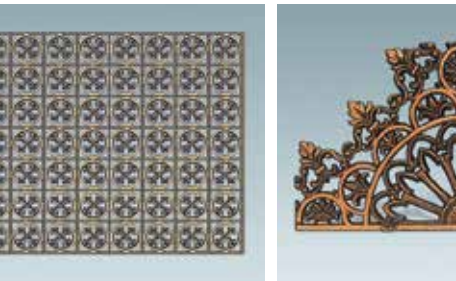

P 679
A:W817XH945XT10
B:W480XH165XT10
C:W245XH160XT10



P 695
A:W315XH315

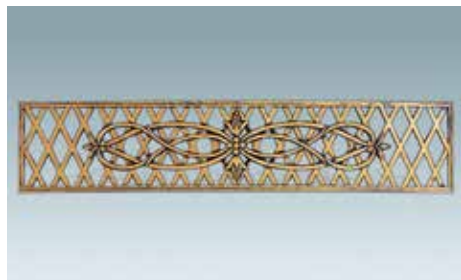

G 716 W1000XH210



CJD 721
W1000(573)XH500(385)



CJD 722
W1000(573)XH500(385)

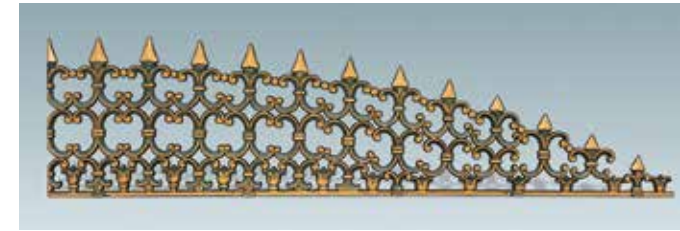

P 680 大:W1800XH380, 小:W1500XH380



P 682 W1235XH315



P 684 W1100XH270



P 685 W1330XH305



P 686 W1070XH190

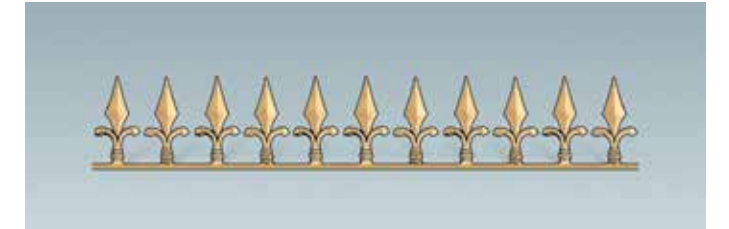

P 688 大:W1300XH200, 小:W1200XH140



P 690 W1000XH250

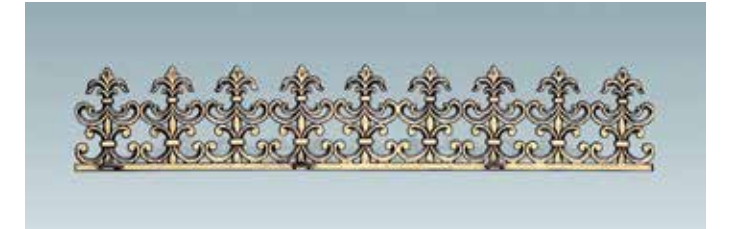

P 691 W1070XH215



P 693 大:W1200XH290, 中:W1000XH245
小:W700XH245

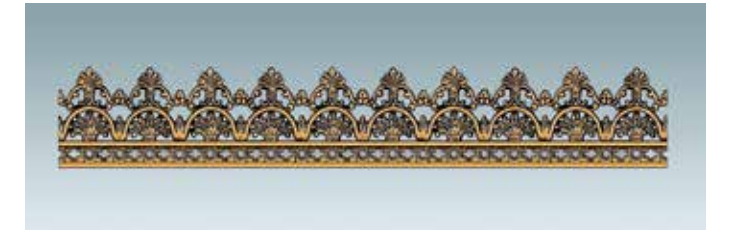

P 694 A:W1000XH130, B:W1000XH165

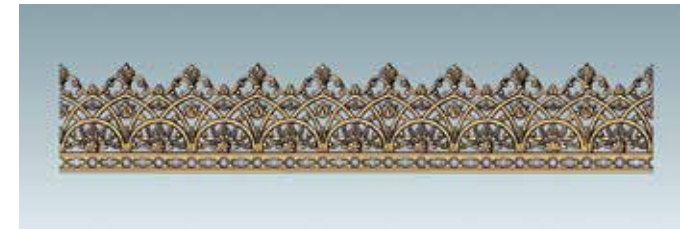

P 694D W1185XH230



P 697 W910XH150

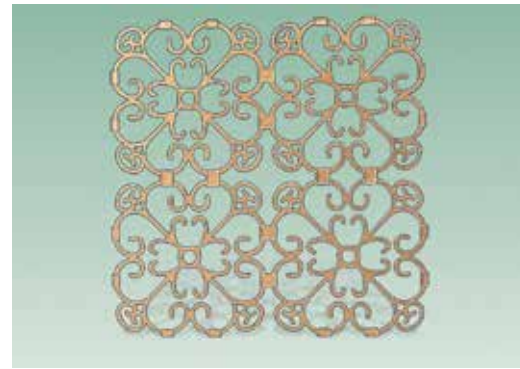
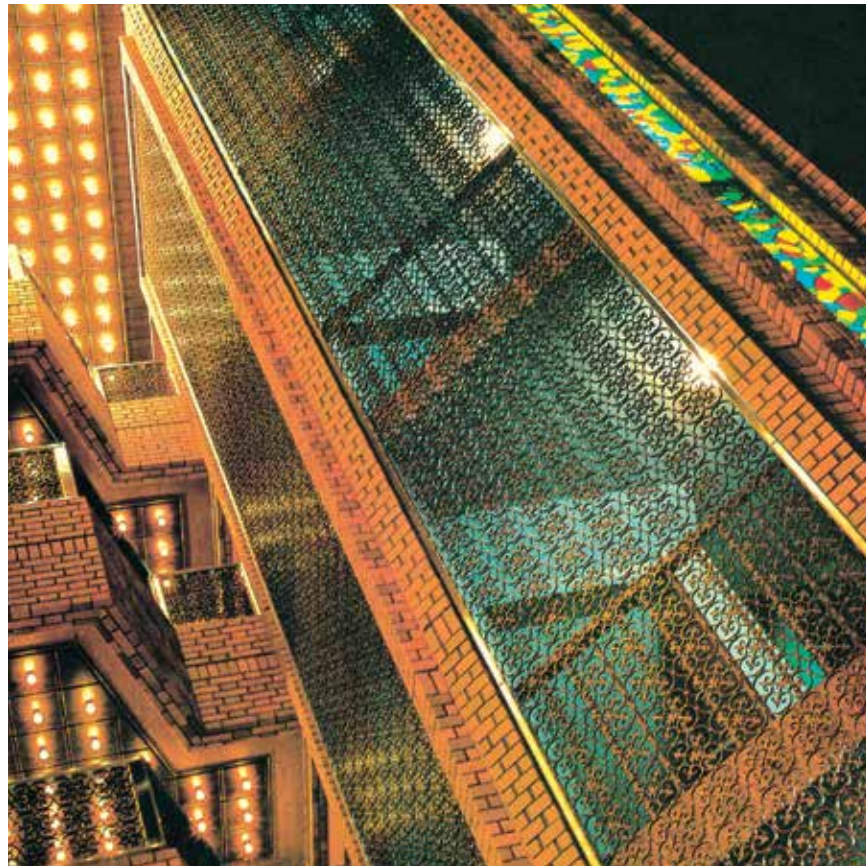

M 108 W300XH300XT8

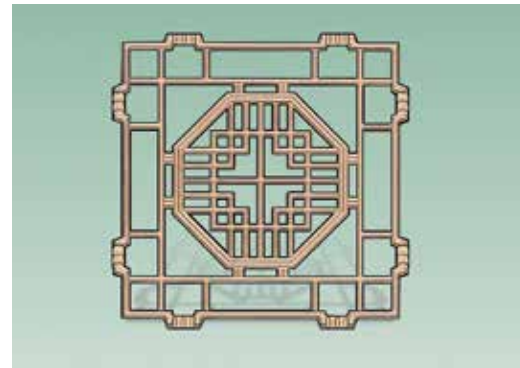

M 109 W300XH300XT8

From refinement to naturalness.
We bring out the eminence without decorating.
The grace beyond eyeshot and the modern atmosphere will take the place of your level.



M 202
大:W1000XH785, 中:W1000XH750, 小:W1000XH650



M 202 설치사례

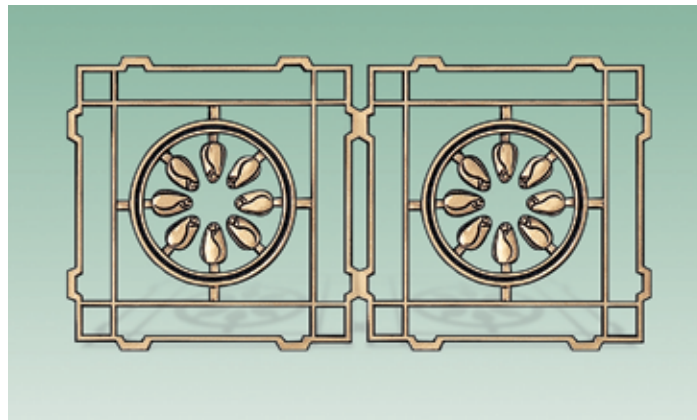

M 101 W200XH400XT9

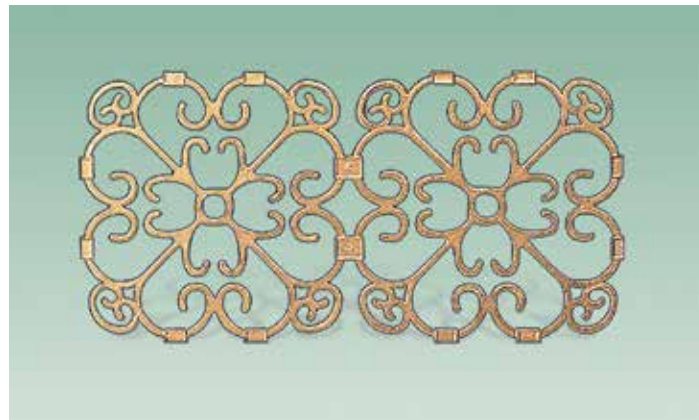

M 102 W200XH400XT8



M 203 A:W1000XH570XT10, B:W1000XH548XT11
C:W1000XH500XT10
D:W1000XH400XT10 (다릿발이 별도로 없음)

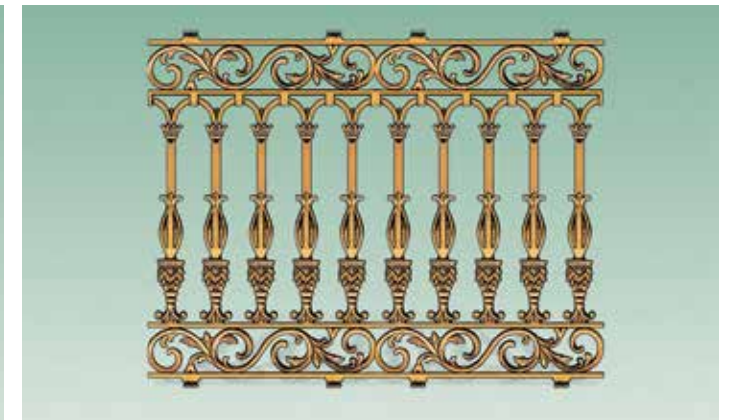

M 204 W1000XH780XT12

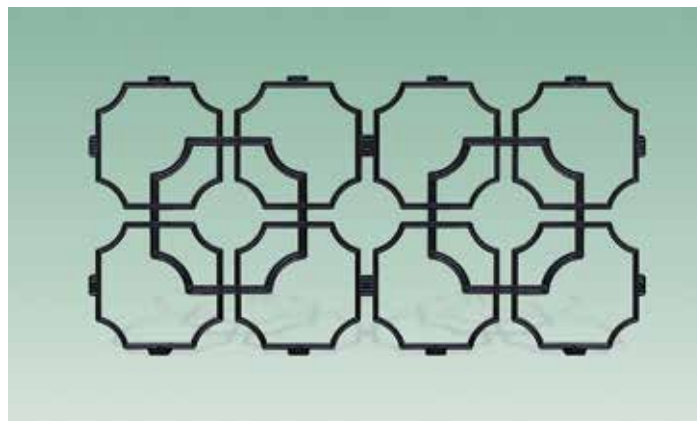

M 103 W200XH400XT14

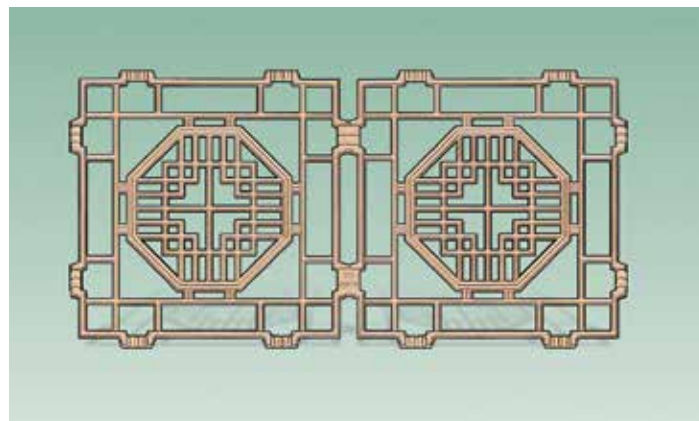

M 104 W200XH400XT8

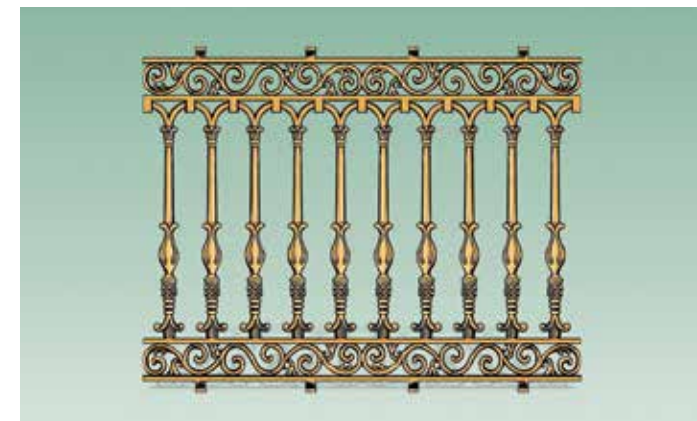

M 205A W1005XH790XT12



M 205B W1005XH600XT12

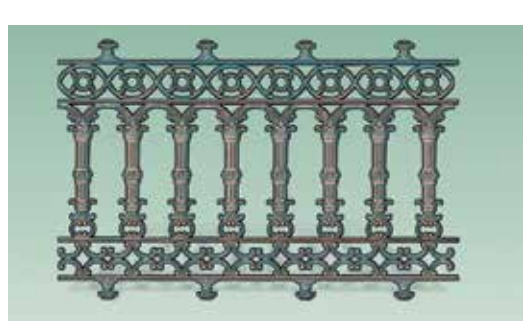
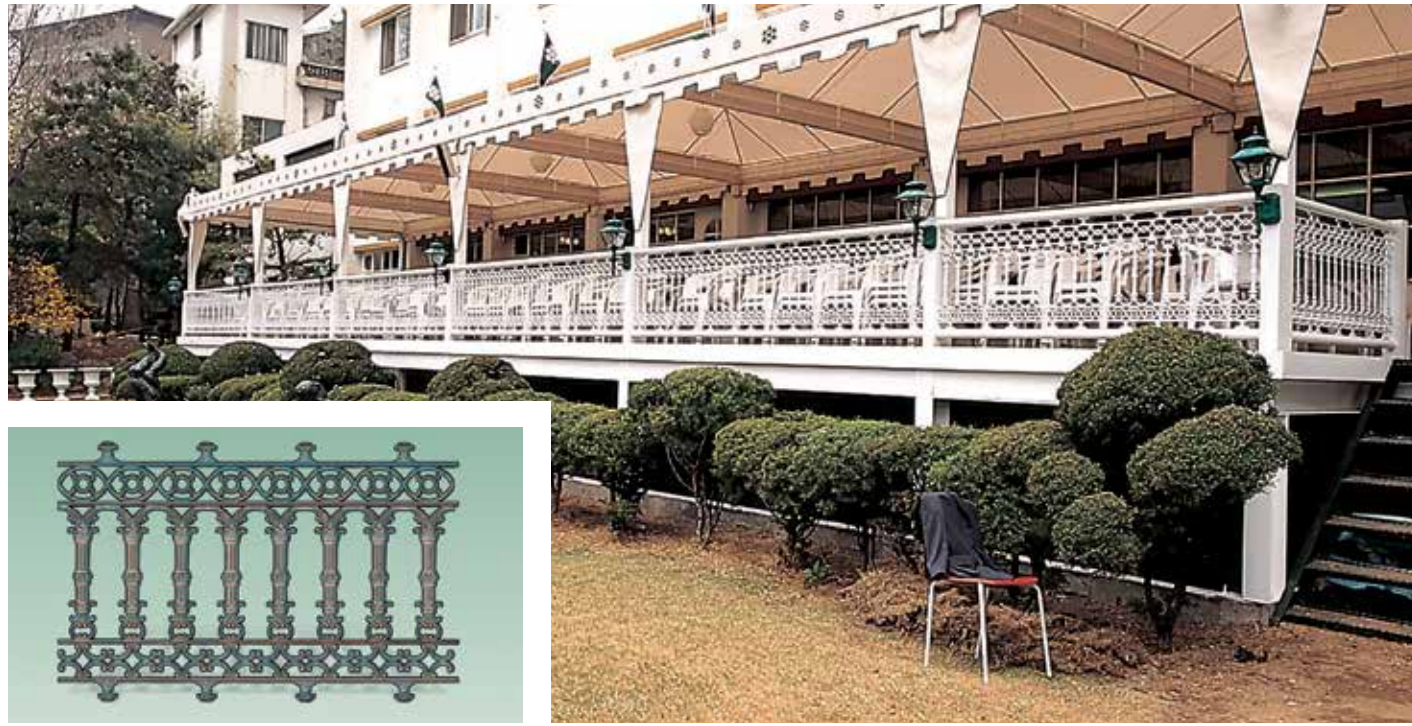

M 206
大:W1000XH800XT16, 小:W1000XH650XT16

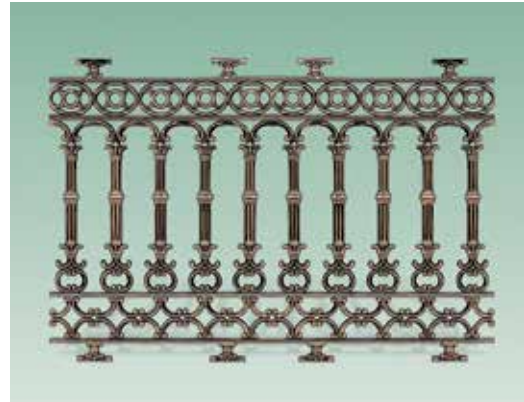

M 207
A:W1000XH750XT13, B:W1000XH690XT12



M 208
W395XH843XT12



M 209
W405XH850XT12



M 210
W355XH765XT12



M 211
W500XH743XT12



M 212
W447XH740



M 213
W425XH770XT15



M 214
W450XH790XT13



M 215
W300XH850XT10



M 216
W440XH755



M 217
W462XH750XT12



M 220 大
W800XH755(655)XT13



M 220 中:W600XH750XT10
小:W590XH625XT10



M 221
W500XH760



M 221-1
W1030XH760XT12



M 222
W520XH883(806)XT10



M 223
W890XH590XT14



M 224
W775XH490XT12



Nature
Beautiful...

M 222-1 설치사례



M 225 W715XH523XT12



M 226 W805XH560XT12



M 229 W500XH750



M 231 W1000XH400XT13



M 233 W1000XH800XT13



M 232 W1015XH425XT10

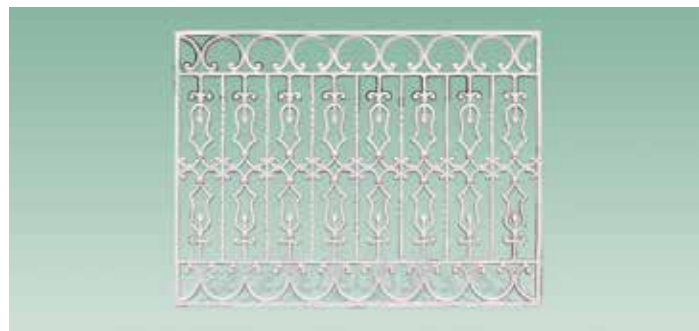

M 235 W1000XH760XT12



J 281 W800XH1000XT15



J 282 W1000XH900XT15

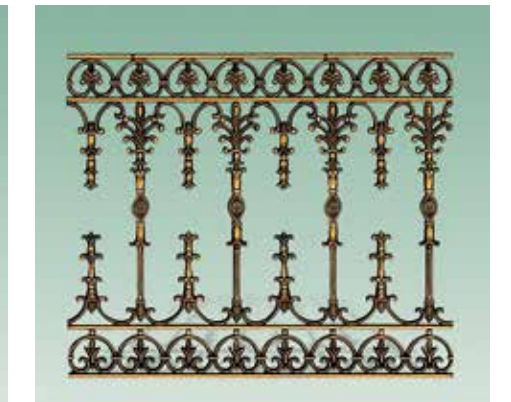

J 286 W1000XH850XT20



J 287 W1000XH1000XT18



J 287-1
大:W1000XH1000, 小:W1000XH800

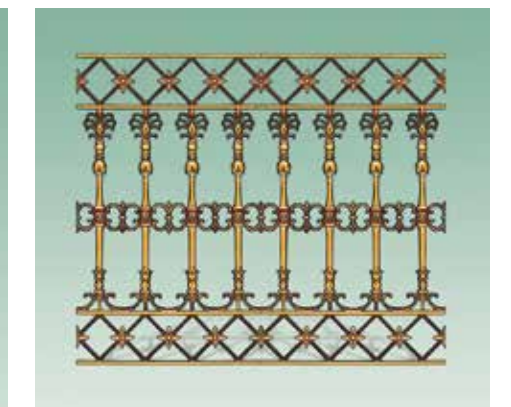

J 288
大:W1000XH1150, 小:W1000XH850

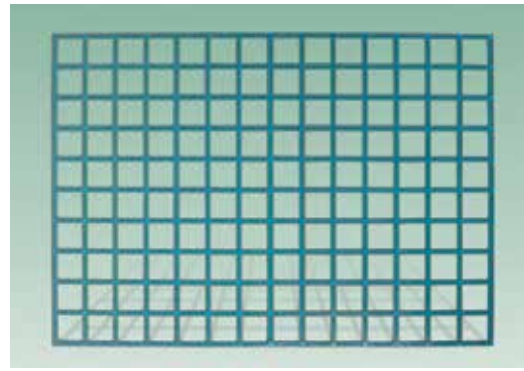

M 120 W1060XH755

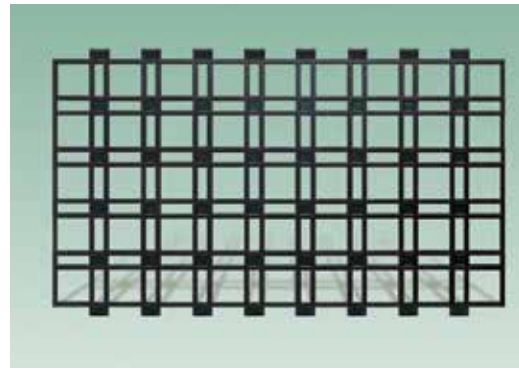

M 122 W935XH550XT16

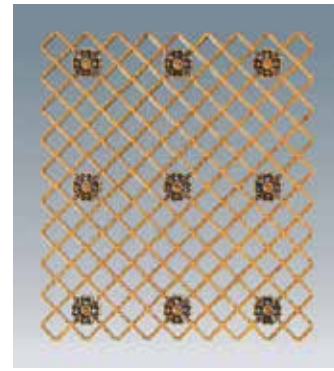

M 123 W840XH940



M 227 W720XH720XT10



M 240 W885XH445XT14



J 290 W2000XH550



M 228 W660XH660XT15



M 241 W985XH495XT14

From refinement to naturalness.
We bring out the eminence without decorating.
The grace beyond eyeshot and the modern atmosphere will
take the place of your level.

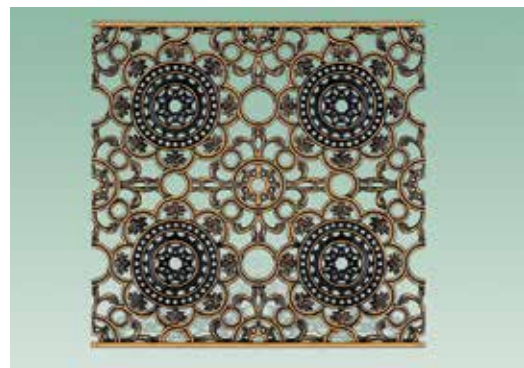

M 230 W880XH880



M 238 W435XH945XT12



M 237 W450XH970XT10



M 234

- 1)W800XH585XT14
- 2)W1030XH595XT10
- 3)W1000XH1000XT12
- 4)W1000XH800XT12
- 5)W1000XH550XT12
- 6)W1000XH400XT12
- 7)W1000XH500XT12





M 255 A, B, C 천연색



M 255 A:W1000XH800



M 255 B:W1000XH800



M 255 C:W1000XH800

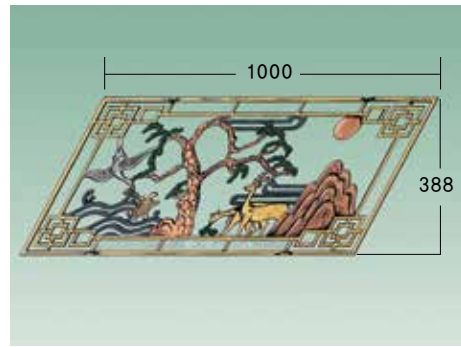

M 243 W1000XH388(계단용)

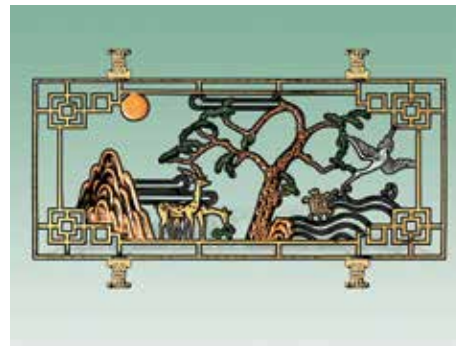

M 2431 A:W1000XH700

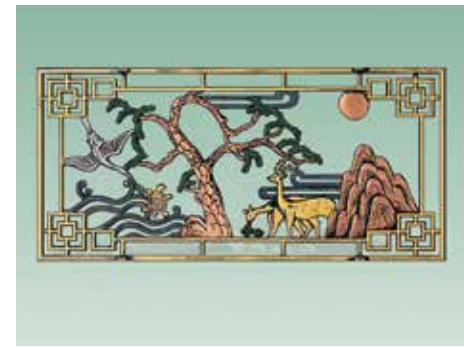

M 2431 B:W1000XH600



M 243 A:W1000XH500XT13
B:W1000XH450XT13



M 245 大:W1000XH800XT13
中:W1000XH600XT13
小:W800XH500XT13



M 247 W425XH550



M 248 W480XH650XT12

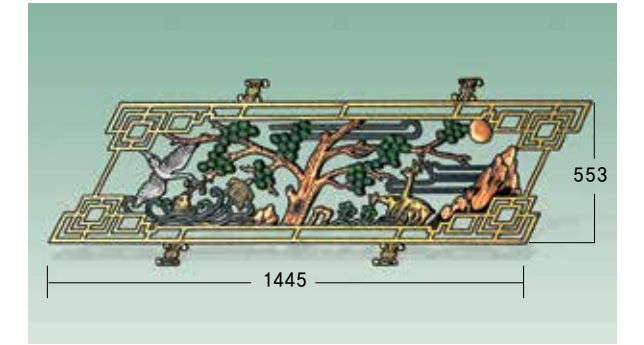

M 250 W1445XH553(계단용)

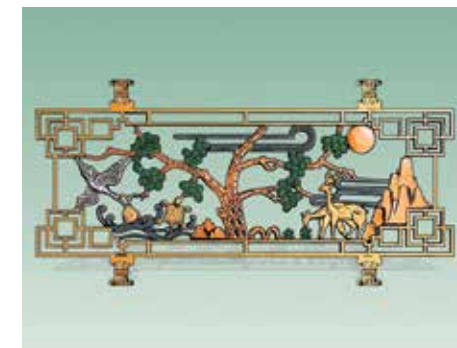

M 251 大:W1500XH650



M 251 小:W750XH650



M 251 中:W1000XH750



G 733 W600(350)XH600(350)

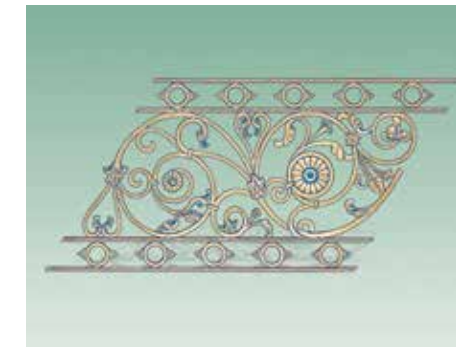

M 260 W1030XH650XT13(계단용)



M 261 W1000XH650XT13



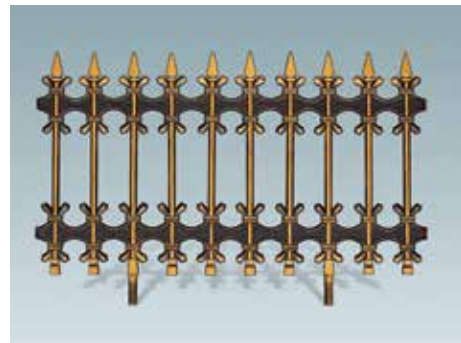

AF 801 A:W1005XH650(570)XT9
B:W1000XH550(470)XT9

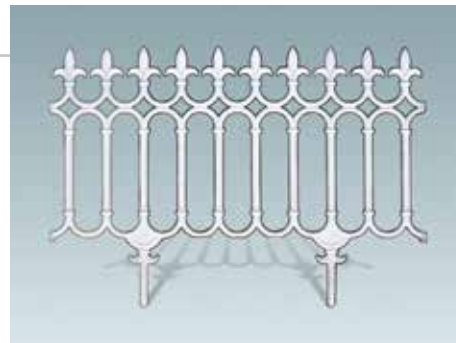

AF 802 W1000XH700(590)XT16

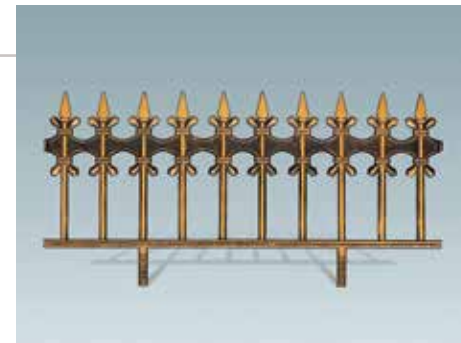

AF 804 W1000XH490(390)XT13



AF 806 설치현장 / W1000XH600(500)XT13



AF 805 W1000XH610(480)

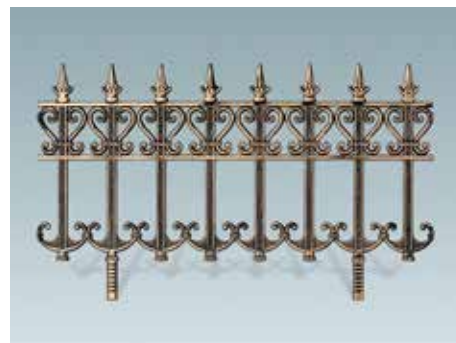

AF 806 A:W1000XH700(600)XT12
B:W1000XH600(505)XT12

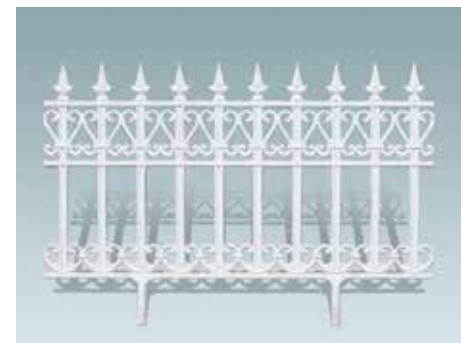

AF 806C W1000XH670(500)



AF 815 설치현장 / W1000XH610(500)XT13

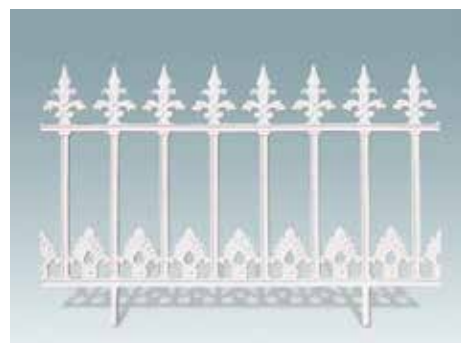

AF 807 W1000XH650(550)

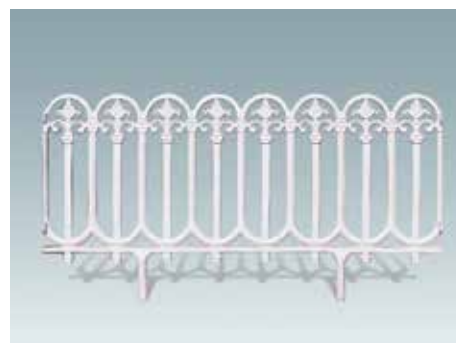

AF 808 A:W1000XH530(430)

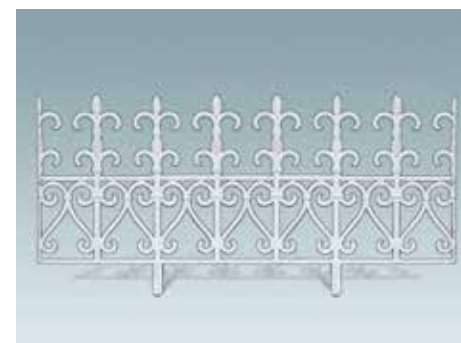

AF 810 W1000XH520(405)



AF 803N W1000XH700(600)



AF 809 W1005XH700(600)

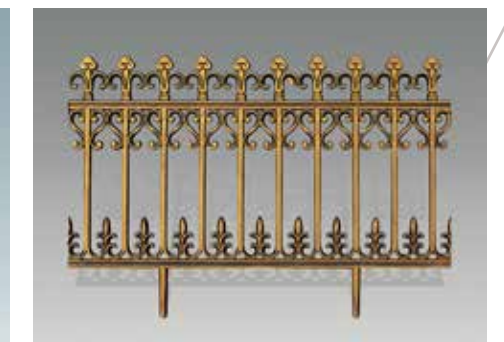

AF 864 中:W1000XH780(660)
小:W1000XH650(530)



AF 811 W1005XH515(415)

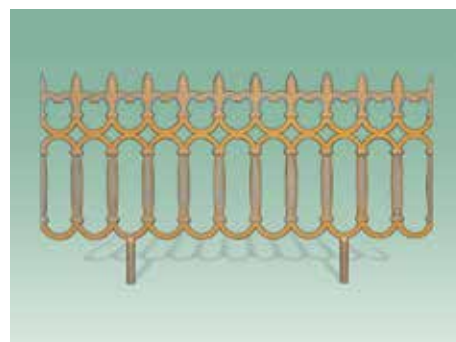

AF 812 W1000XH540(430)

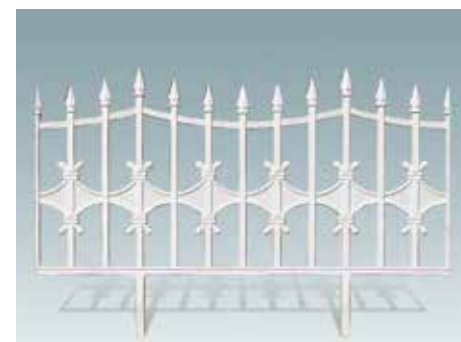

AF 814 A:W1000XH950(800)
B:W1000XH650(500)



AF 828 小:W1000XH500(400)



AF 829N W1000XH430(300)

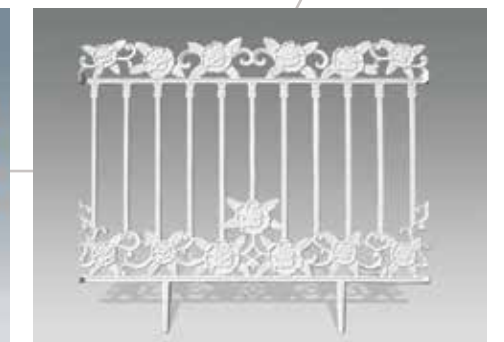

AF 866 大:W1000XH1050(900)
中:W1000XH850(700)
小:W1000XH550(400)



AF 820 양평 전원주택단지



AF 826 W1000XH670

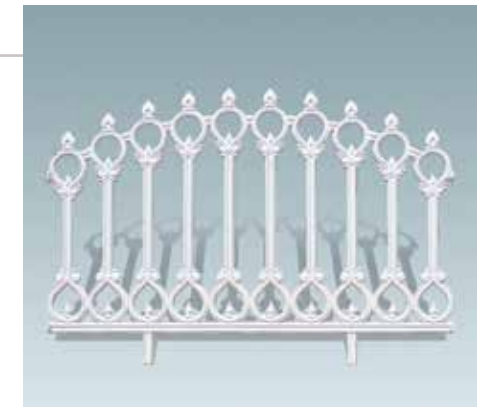

AF 827 W1000XH670

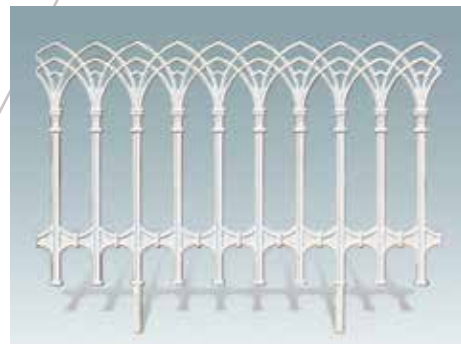

AF 820 A:W1000XH820(700)
B:W1000XH720(620)
C:W1000XH510(400)



AF 823 W1000XH650(550)



AF 824 W970XH600(480)

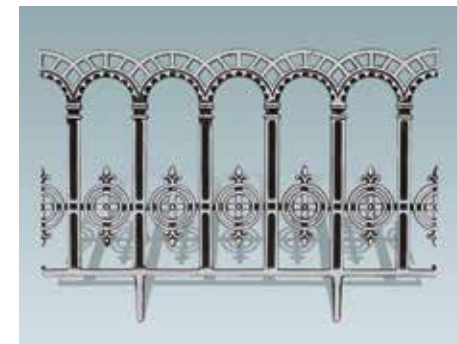

AF 828 大:W1000XH850(730)
中:W1000XH690(570)
小:W1000XH500(400)



AF 834 W1005XH750(600)XT18

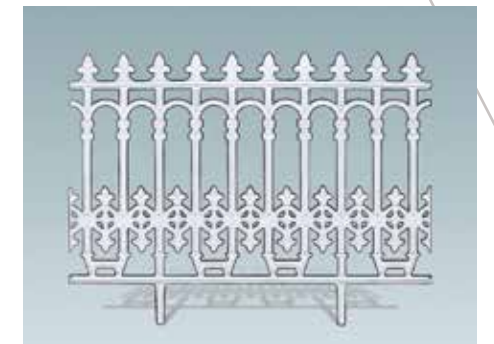

AF 835 大:W1000XH810(720)
小:W1000XH670(550)



AF 825 W1000XH600(450)



AF 842 W1000XH730(600)

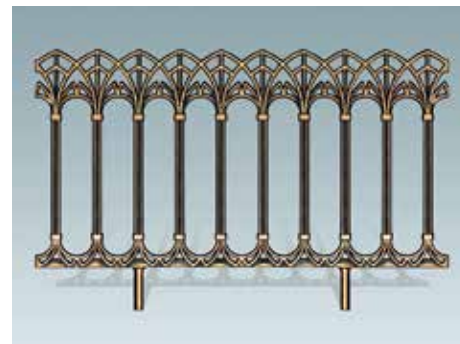

AF 831 A:W1000XH950(850)
B:W1000XH650(550)



AF 837 A:W1000XH860(740)XT17
B:W1000XH970

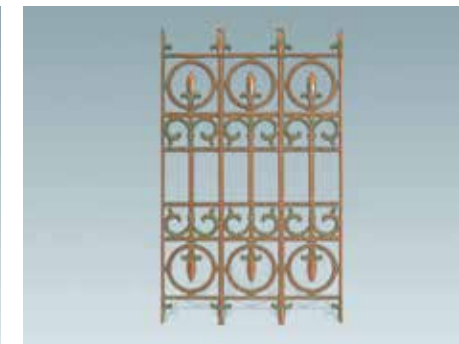

AF 838 W650XH985



AF 840 W1000XH880(750)XT16



AF 857 A:W1000XH710(610)



AF 833 大:W2000XH1000(850) / 小:W2000XH780(650)



AF 1018 A:W1000XH945(800)
B:W1000XH780(660)



AF 835 大:W1000XH820(720) / 小:W1000XH670(550)XT16



AF 1019 B:W1000XH1550XT20 / C:W1000XH1300 / D:W1000XH1130



AF 858 W1000XH1000(870)XT18



AF 861 설치현장



AF 862 A:W1000XH950(800)XT20

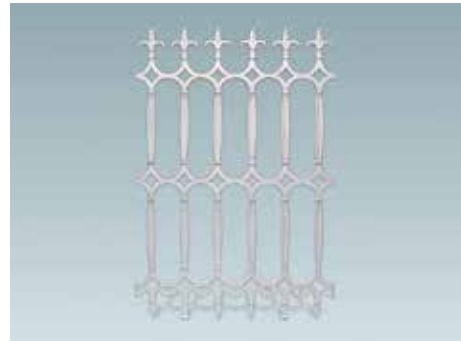

AF 851 W1025XH1050(950)XT14



AF 853 W1000XH850(700)XT18



AF 854 W970XH900(765)XT18



AF 859 W1000XH1000XT14

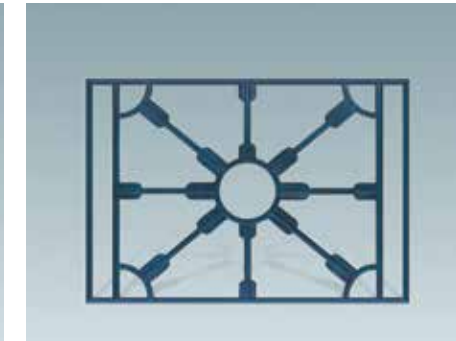

AF 863 W1160XH805XT17

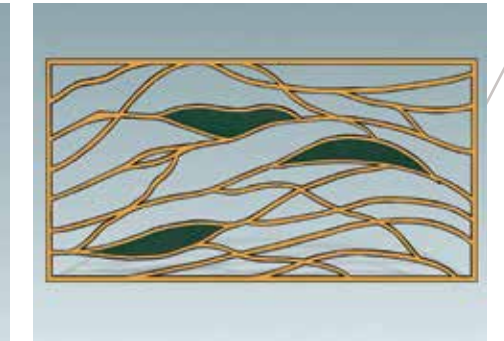

AF 865 W1435XH750XT15

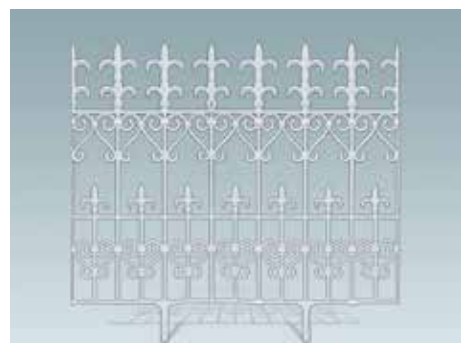

AF 855 W1000XH900(785)XT13



AF 1013
A:W1000XH1135 / B:W1000XH960
C:W1000XH1350 / D:W1920XH1550



AF 1019 B:W1000XH1550(1400)
C:W1000XH1300(1150)
D:W1000XH1130(995)

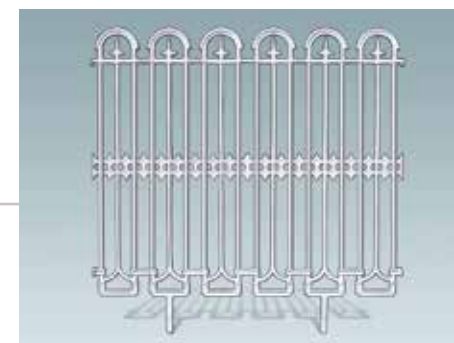

AF 1015 W1000XH995(870)XT17

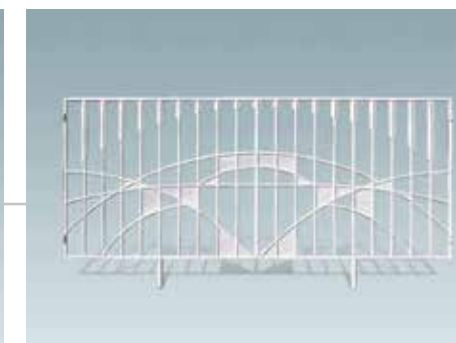

AF 861 W1920XH945(800)XT18



AF 849 大:W1000XH1300(1150)
中:W1000XH1070(950)
小:W1000XH700(600)



AF 849 大:W1000XH1300(1150) / 中:W1000XH1070(950) / 小:W1000XH750(600)



AF 1057 W1920XH1350(1200)XT22



AF 1029 W1000XH1230(1050)XT10



AF 1072 W1900XH1100(1000)



AF 1023 大:W1000XH1400 / 소:W1000XH1100



AF 1085 W1920XH1200



AF 1058 W1920XH1200



AF 1056 W1920XH1350



AB 401
W260XH890~
955XT13



AB 402
W165XH870~
940XT15



AB 415
W140XH820~
910XT15



AB 416
W100XH835~
910XT20



AB 417
W155XH700~
885XT14



AB 420
W140XH850~
910XT15

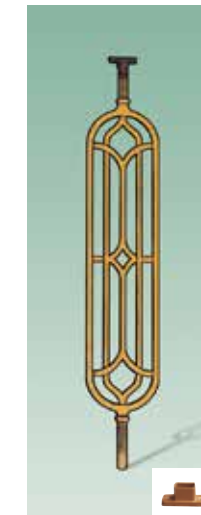

AB 421
W165XH850~
910XT15



AB 423
W160XH850~
890XT12



AB 403
W183XH860~
970XT12



AB 404
W145XH865XT14



AB 405
W230XH830~
905XT10



AB 406
W250XH860XT12



AB 407
W165XH790~
848XT12



AB 408
W165XH820~
915XT12



AB 424
W170XH750~
840XT11



AB 425
W140XH800~
870XT16



AB 409
W200XH750~
825XT15



AB 410
W165XH790~
880XT13



AB 411
W190XH750~
835XT13

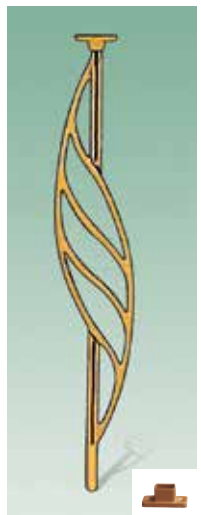

AB 412
W145XH840~
910XT12



AB 413
W155XH800~
920XT13



AB 414
W165XH880~
960XT13



AB 326
A:W65XH720
B:W65XH485
C:W47XH360



AB 321
A:W105XH830
B:W105XH595
C:W100XH438





AF 817 A:W1000XH370(200)XT13 / B:W1000XH440(300)XT16



AF 819 W1000XH550(400)XT18



AF 818 W1000XH440XT18



AF 830 W1000XH500(360)XT14



B 201A



B 202

Aluminium Door

저희 Plus Door는 미적감각과 생활의 편리함을 추구하며 질 좋은 제품과 축적된 기술로 여러분의 행복한 가정을 꾸며 드립니다.

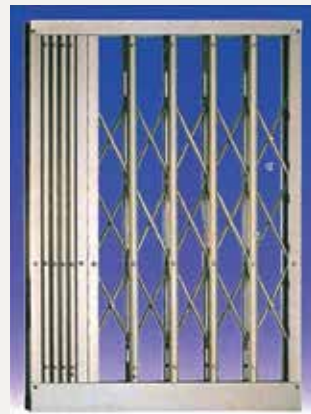

자바라 이탈방지 특수수지

Grille Designs

색상 : 아나로그, 스텐칼라, 주문색상

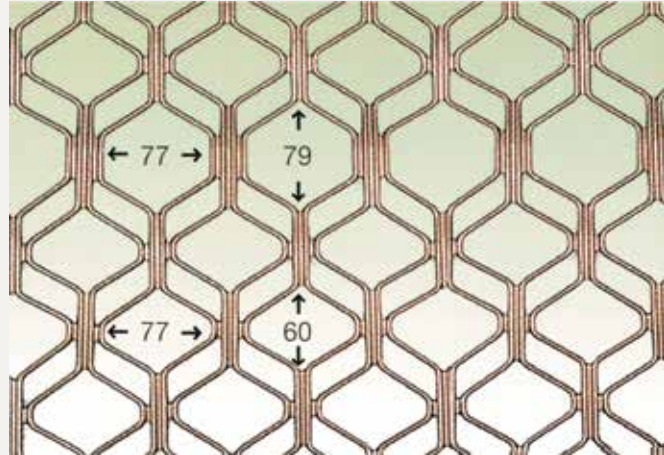

006(A)

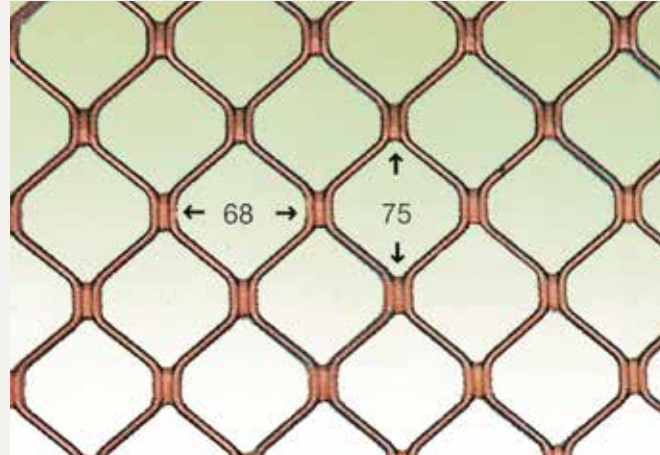

007(B)

WXL(mm)	M당 중량
750X6000	3.0Kg
900X6000	3.5Kg
1200X6000	4.0Kg
의장등록 출원 제22700호	

WXL(mm)	M당 중량
750X6000	2.1Kg
900X6000	2.5Kg
1200X6000	3.4Kg
1500X5300	4.3Kg

Plus Accessories

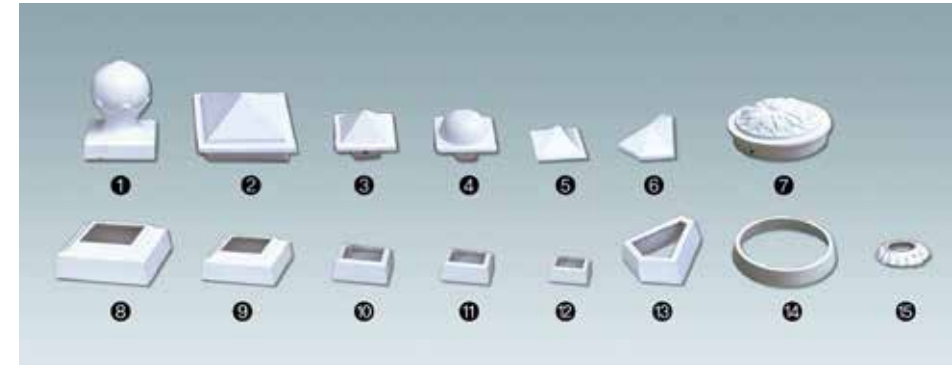

- 캡1 ①100X100, 80X80 ②80X80, 100X100 ③50X50, 45X45 ④55X55 ⑤55X55
⑥80X80(코너캡上) ⑦125Ø, 150Ø(대문기동上) ⑧100X100 ⑨80X80 ⑩55X55
⑪50X50 ⑫45X45 ⑬80X80(코너캡下) ⑭125Ø, 150Ø(대문기동下) ⑮담장용하부캡

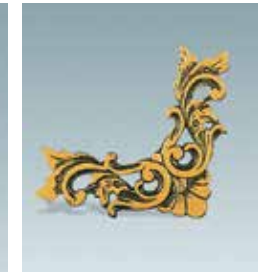

가네고



H-1
W94XH380



- 캡2 ①200X200, 150X150 ②125X125 ③30Ø ④80Ø ⑤80X80
⑥80X80 ⑦56X55 ⑧50X50 ⑨78Ø ⑩84Ø(내경) ⑪584Ø(내경)



H-2
W80XH325

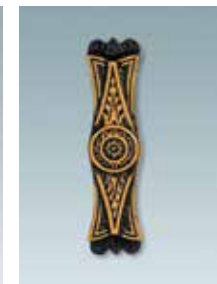

H-3
W70XH300



H-4
W70XH338



신주힌지

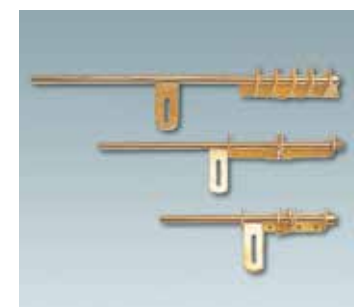

신주빗장

大:600(17Ø), 中:450(13Ø)
小:300(13Ø)



스텐빗장

大:600(17Ø), 中:450(13Ø), 小:300(13Ø)



H-5
W110XH230

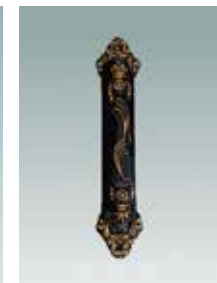

H-6
W60XH400



H-7
W60XH400



H-102



H-109



H-7
W60XH400



정지대



화살촉

22,5Ø(25Ø내부사입)